

Grupo

BRAMONIX

DISTRIBUIDOR EXCLUSIVO **PINTINOX**

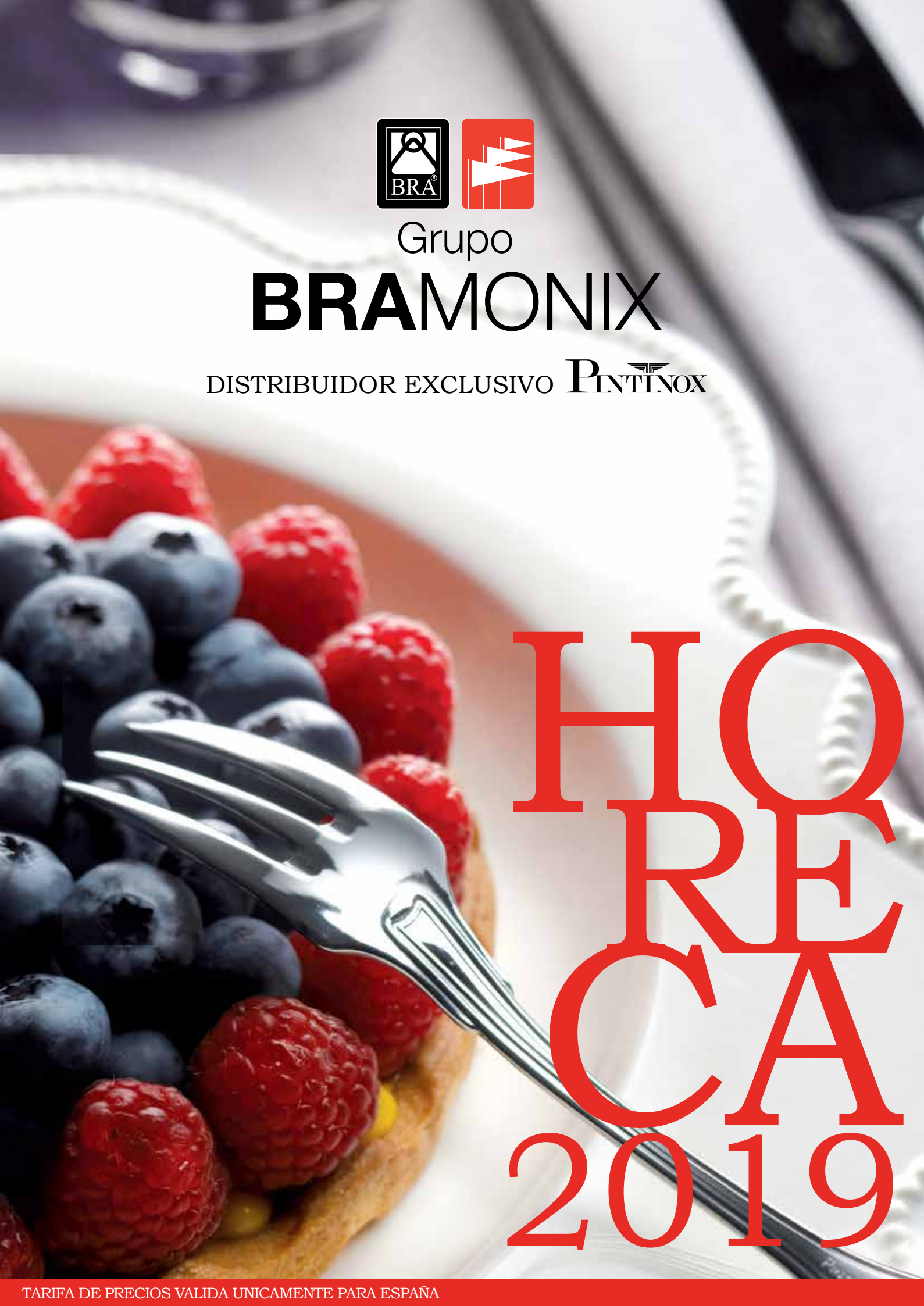

**HO
RE
CA
2019**

0001	Cucchiaio tavola - Table spoon - Cuiller de table - Tafellöffel - Cuchara mesa
0002	Forchetta tavola - Table fork - Fourchette de table - Tafelgabel - Tenedor mesa
0003	Colt. tavola - Table knife - Couteau de table - Tafelmesser - Cuchillo mesa
00CC	Colt. tav. m.v. lama forgiata - Table knife H.H and forg. blade - Cout. de table à m.c. et lame forg. - Tafelhohlheftm. mit geschm. Klinge - Cuch. mesa con m.h. y hoja forj.
00CA	Colt. tav. senza bilancio - Special table knife - Couteau de table spécial - Tafelmesser spezial - Cuchillo mesa
00L3	Colt. tav. stamp. - Stamp. table knife - Cout. de table estampé - Tafelmesser - Gestanzt Cuc. mesa estampado
0067	Coltello bistecca - Steak knife - Couteau à steak - Steakmesser - Cuchillo chuleta
0004	Cucchiaio frutta - Dessert spoon - Cuiller dessert - Dessertlöffel - Cuchara postre
0005	Forchetta frutta - Dessert fork - Fourchette dessert - Dessertgabel - Tenedor postre
0006	Coltello frutta - Dessert knife - Couteau dessert - Dessertmesser - Cuchillo postre
00L6	Colt. frutta stamp. - Stamp. dessert knife - Cout. dess. estampé - Dessertmess. gestanzt - Cuc. postre estamp.
00CD	Colt. frutta m.v. lama forg. - Des. knife H.H and forg. blade - Cout. des. à m.c. et lame forg. - Dessertlöffel mit geschm. Klinge - Cuch. postre con m.h. y hoja forj.
00CB	Colt. frut. senza bilancio - Special dessert knife - Cout. dessert spécial - Dessertmess. spezial - Cuc. postre
0007	Cucchiaino caffè - Tea-coffee spoon - Cuiller à café - Kaffeelöffel - Cuchara café
0008	Cucchiaino moka - Moka spoon - Cuiller à moka - Mokkalöffel - Cuchara moka
0010	Mestolo - Soup ladle - Louche - Suppenschöpfer - Cazo sopa
0011	Cucchiaine - Serving spoon - Cuiller de service - Gemüselöffel - Cuchara servir
0012	Forchettoni - Serving fork - Fourchette de service - Serviergabel - Tenedor servir
0013	Mestolo salsa - Sauce ladle - Louche à sauce - Saucenlöffel - Cuchillo salsa
0014	Cucchiaio insalata - Salad spoon - Cuiller à salade - Salatlöffel - Cuchara ensalada
0015	Forchetta insalata - Salad fork - Fourchette à salade - Salatgabel - Tenedor ensalada
0016	Forchettina dolce 4 spine - Pastry fork - Fourchette à gateau - Kuchengabel 4 Zinken - Tenedor postre 4 púas
0059	Cucchiaine risotto - Rice spoon - Cuiller à "risotto" - Reislöffel - Cuchara de arroz
00AW	Mestolo Zakouski - Zakouski ladle - Louche Zakouski - Zakouski schöpfer - Cuchillo Zakouski
0017	Forchettina dolce 3 spine - Pastry fork - Fourchette à gateau - Kuchengabel 3 Zinken - Tenedor postre 3 púas
0018	Cucchiaino dolce - Tea-cake spoon - Cuiller à gateau - Kuchenlöffel - Cuchara postre
00L9	Coltellino stamp. - Stamp. cake knife - Cout. à gateau estampé - Kuchenmess. gestanzt - Cuch. estampado
0019	Coltellino dolce - Pastry knife - Couteau à gateau - Kuchenmesser - Cuchillo postre
0020	Pala torta - Cake server - Pelle à tarte - Tortenheber - Pala pastel
0052	Cucchiaino bebè - Baby spoon - Cuiller à bébé - Babyloeffel - Cucharita bebè
00CR	Cucchiaio crema - Cream spoon - Cuiller à crème - Sahnelöffel - Cuchara crema
0009	Forchetta carne - Meat fork - Fourchette à viande - Vorlegegabel - Tenedor carne
0022	Paletta gelato - Ice cream spoon - Cuiller à glace - Eislöffel - Cuchara para helado
0023	Cucchiaio formaggio - Grated-cheese spoon - Cuiller à parmesan - Käselöffel - Cuchara para queso
0025	Spalma burro - Butter spreader - Couteau à beurre - Buttermesser - Pala mantequilla
00CS	Colt. burro m.v. lama forg. - Butter spreader H.H. and forged blade - Cout. à beurre à m.c. et lame forg. - Hohlheft-Butter messer mit geschm. Klinge - Pala manteq. con m.h. y hoja forj.
0026	Forchetta lumache - Snail fork - Fourchette à escargots - Schnecken-gabel - Tenedor caracoles
0027	Forchetta ostriche - Oyster fork - Fourchette à huîtres - Austerngabel - Tenedor ostras
00FM	Forchetta molluschi - Shellfish fork - Fourchette à crustacés - Austerngabel - Tenedor marisco
0035	Sessola zucchero - Sugar spoon - Cuiller à sucre - Zuckerlöffel - Cuchara para azucarera
0036	Cucchiaino bibita - Long drink spoon - Cuiller à drink - Limolöffel - Cuchara refresco
0038	Cucchiaio gourmet/salsa - Gourmet spoon - Cuiller gourmet - Gourmetlöffel - Cuchara gourmet/salsa
0039	Cucchiaio brodo - Soup spoon - Cuiller à soupe - Fleischbrühenlöffel - Cuchara caldo
00AT	Cucchiaio Zakouski - Zakouski spoon - Cuiller Zakouski - Zakouskilöffel - Cuchara Zakouski
0028	Forchetta pesce - Fish fork - Fourchette à poisson - Fischgabel - Tenedor pescado
0029	Coltello pesce - Fish knife - Couteau à poisson - Fischmesser - Cuchillo pescado
0030	Forc. pesce servire - Fish serving fork - Fourc. à servir poisson - Fischserviergabel - Tenedor servir pescado
0031	Colt. pesce servire - Fish serving knife - Cout. à servir poisson - Fischserviermesser - Cuchillo servir pescado

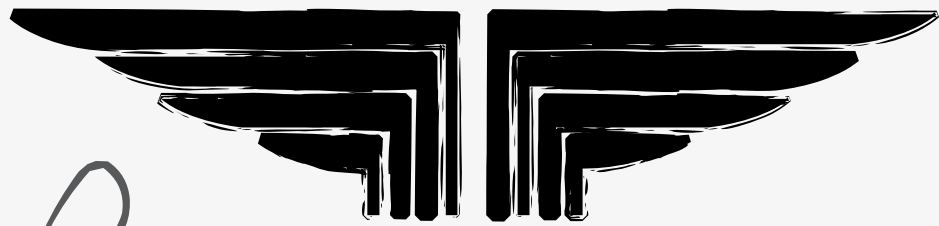

PINTINOX made in Italy

DNV

Quality Certificate

In ottemperanza a quanto stabilito dal decreto legislativo DL 108 dt 25.01.92 e Dir. CEE 1935/2004 e 89/109, si precisa che la posateria, il pentolame ed il vasellame di nostra produzione e distribuzione riportanti i marchi:

In compliance with the ministerial decree D.L. 108 dd 25.01.92 and Dir. EEC 1935/2004 and 89/109, the cutlery, cookware and holloware we manufacture under the brands:

PINTI1929[®]
MADE IN ITALY

PINTINOX
MADE IN ITALY

sono prodotti con materiali idonei al contatto con gli alimenti.

are produced with materials which can be in touch with foodstuff.



DNV BUSINESS ASSURANCE MANAGEMENT SYSTEM CERTIFICATE

Certificato No. / Certificate No. **CERT-07553-2000-AQ-MIL-SINCERT**

Si attesta che / This is to certify that

PINTI INOX S.p.A.

Via Antonini, 87 - 25068 Sarezzo (BS) - Italy

*è conforme ai requisiti della norma per i sistemi di gestione:
has been found to conform to the management system standard;*

UNI EN ISO 9001:2008 (ISO 9001:2008)

*Questa Certificazione è valida per il seguente campo applicativo:
This Certificate is valid for the following product or service ranges:*

**Progettazione e produzione di: posateria, pentolame per uso domestico, alberghiero e catering
e oggetti in acciaio inox per la tavola e la cucina
(Settore EA : 17)**

**Design and manufacture of: cutlery, cookware for domestic, hotels and catering uses,
stainless steel tableware and kitchen accessories.
(Sector EA : 17)**

Data Prima Emissione/Initial Certification Date:

2000-12-14

*Il Certificato è valido fino al:
This Certificate is valid until:*

2018-03-04

*L'audit è stato eseguito sotto la supervisione di/
The audit has been performed under the supervision of*

Alessandra Gadaleta
Lead Auditor



ACCREDIA
Società a partecipazione paritetica
DIPARTIMENTO REGIONALE
DIP. REG. FINE 107-107-107-107 per gli settori di
certificazione UNI, EN, ISO, IEC, ecc.
e di ACCREDITAZIONE UNI

Luogo e Data/Place and Date:

Vimercate (MB), 2015-02-04

*Per l'Organismo di Certificazione:
For the Certification Body:*

Zeno Beltrami
Management Representative

La validità del presente Certificato è subordinata al rispetto delle condizioni contenute nel Contratto di Certificazione.
Lack of fulfillment of conditions as set out in the Certification Agreement may render this Certificate invalid.

DNV GL Business Assurance Italia S.p.A. - Via Marconi, 100 - 20121 Milano (MI) - Italia - Tel. 02 8748 9999 - www.dnvgl.com



**CLUB
DEL BUONGUSTAI**
Centro della polimerizzazione europea



CONFINDUSTRIA

UNIONE NAZIONALE CONSUMATORI
COMITATO PROVINCIALE DI BRESCIA

Descrizioni delle diverse qualità di acciai per posate

Description of different steel grade used for cutlery

Acciaio inox 18/10

Acciaio 18% cromo

L'acciaio inox 18/10 AISI 304 e inox 18% cromo AISI 430, vengono forniti esclusivamente dalle principali acciaierie europee. La loro eccezionale resistenza alla ruggine, la brillantezza e le caratteristiche igieniche soddisfano i requisiti della moderna gastronomia; essi infatti resistono agli acidi contenuti nei generi alimentari e nei detersivi ed è antiurto. Gli acciai AISI 304 e 430 sono particolarmente adatti al lavaggio in lavastoviglie.

18/ 10 stainless steels

18% chrome stainless steels

Pinti 18/10 AISI 304 and 18% CHROME AISI 430 stainless steel are supplied almost exclusively by the main European steelworks. Their exceptional rust resistance, their brilliance and hygienic qualities satisfy the requirements of modern gastronomy; in fact, they resist the acids contained in foodstuffs, detergents and they are shockproof. 18/10 and 18% chrome are dishwasher safe.



Caratteristiche tecniche di costruzione delle posate

Technical characteristics for the
manufacture of cutlery



1

Lamiera da coils
Coils sheet
Rouleau de tôle
Band-blech
Chapa de bobina



2

Trancitura
Blanking
Découpage
Stanzen
Corte



3

Laminazione
Rolling
Laminage
Walzen
Laminado



4

Ritrancio tazza
Bowl cutting
Découpage cuillère
Erneutes stanzen Mulde
Recorte cuchara



5

Coniatura
Embossing
Estampage
Prägen
Estampación



6

Lucidatura prodotto finito
Polishing finished product
Polissage produit fini
Polieren des Fertigproduktes
Pulido mecanico del cubierto

Caratteristiche tecniche di costruzione dei coltelli

Technical construction features

Coltello monoblocco con lama temperata.

Solid knife with hardened blade. Couteau monobloc avec lame trempée.

Monoblockmesser mit gehärteter Klinge. Cuchillo monobloc hoja templada.

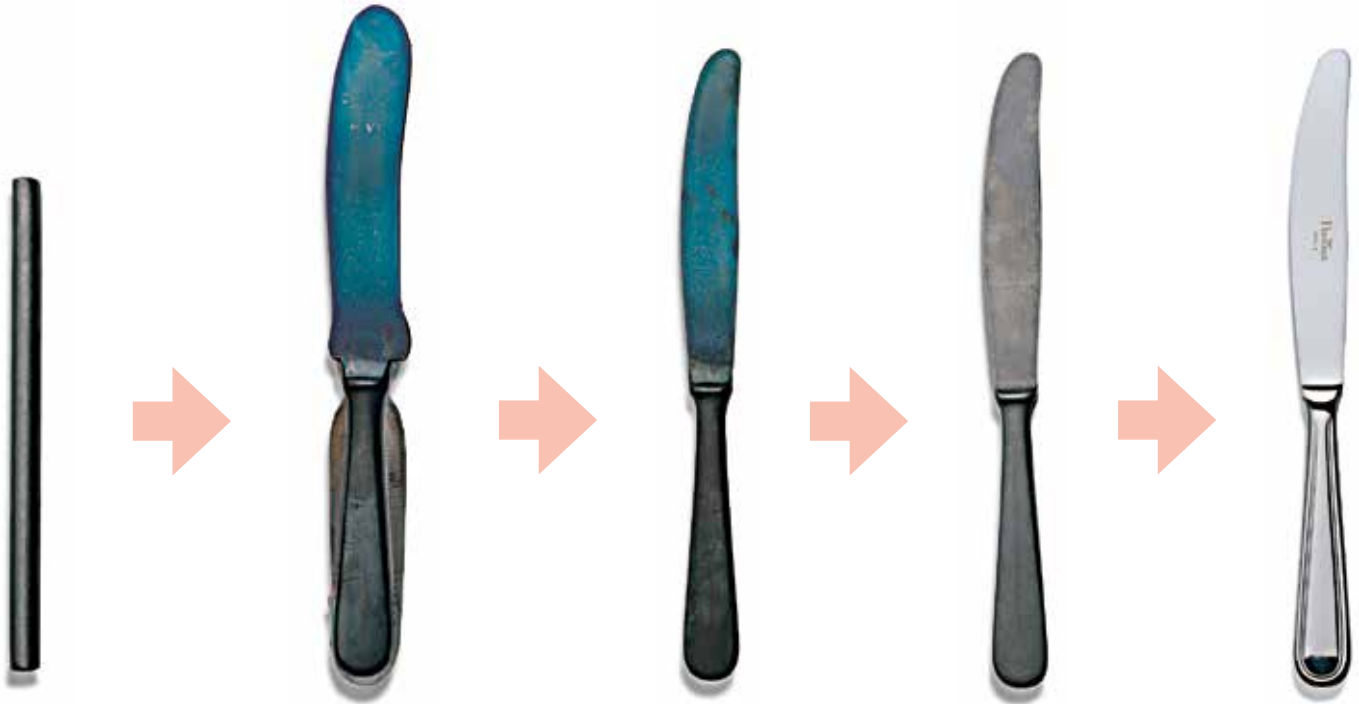

1 AISI 420
Barra d'acciaio
Steel bar
Barre d'acier
Stahlstab
Barra de acero

2 Partic. fucinato
Forged piece
Pièce forgée
Geschmiedet
Pieza forjada

3 Partic. ritranciato
Blanked piece
Pièce découpée
Gestanzt
Cort. de pieza

4 Partic. molato
Ground piece
Pièce meulée
Geschliffen
Acero amolado

5 Prodotto finito
Finished product
Produit fini
Fertiges produkt
Prod. acabado

Coltello con manico cavo e lama fucinata.

Hollow handle knife with forged blade. Couteau à manche creux et lame forgée.

Hohlheftmesser mit geschmiedeter Klinge. Cuchillo con mango hueco y hoja forjada.



1 Lama fucinata
Forged blade
Lame forgée
Geschmiedete Klinge
Hoja forjada

2 Manico cavo
Hollow handle
Manche creux
Hohler Griff
Mango hueco

Inoxidabilidad del acero para cuchillos y hojas

Conforme a lo dispuesto en la ley N.126 of 10/04/1991 "Normas para la información del consumidor" se informa a los usuarios de hojas y cuchillos sobre el uso correcto del producto, para evitar fenómenos corrosivos.

1. Lavar las hojas inmediatamente después de uso.
2. Utilizar detergentes neutros ó poco alcalinos.
3. Evitar frotar las hojas y cuchillos con:
 - a) productos abrasivos, en particular si contienen cloro
 - b) limpiadores metálicos ó sintéticos.
4. No emplear lejías en el lavado, ni tampoco detergentes que contengan cloro y cloruros libres.
5. Secar inmediatamente después del lavado con paños suaves y absorbentes.
6. El secado en lavajillas no es, en general, suficiente para evitar riesgos de corrosión. Es por tanto necesario realizar un cuidadoso secado a mano inmediatamente después del ciclo de lavado.

Las precauciones descritas son indispensables para evitar daño irreparable en las hojas y los cuchillos.

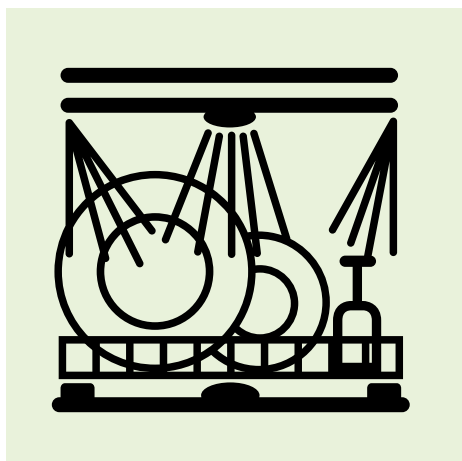
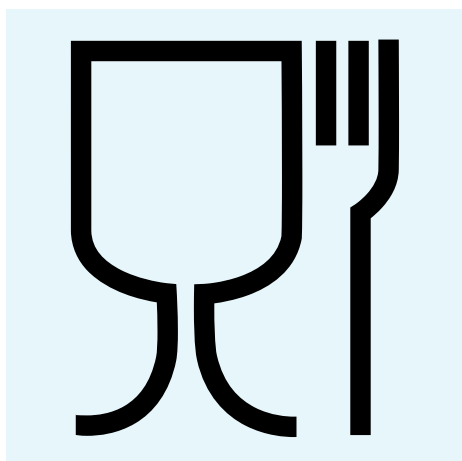

Posate

Cutlery Couverts Bestecke Cubiertos

11



Confezioni

Box Boite Geschenkpackung Confección

70

Gli Speciali

Esclusivi Speciali Professional Astra

81

Cottura

Cooking Cuisson Küchen Cocción

104



Preparazione

Preparation La préparation Vorbereitung Preparación

123



Presentazione

Presentation Présentation Präsentation Presentación

129



Utensili

Tools Ustensiles Zubehör Utensilios

149



Bar

Utensils Articles de bar Barartikel Menaje de cafetería

180





findet/

man die sich

wenn

was

stiffen

Glic

stens

nen/ G

ich; Be

ne zu

zu III

die

göttl

l/ a

ose

ru/

ud

ich

ra

weissung

geord

Bey

mel

erzen

vora

chto

nter

03421

Fry

Ka

Thu

Au

Wach Sporn

Arbeits

Ich meine das die

ist ein loy der

Wien Lang sein

mit

For the



Posate

Cutlery
Couverts
Bestecke
Cubiertos

PINTINOX
MADE IN ITALY

Hotel
Division

PINTI1929[®]
MADE IN ITALY

Relais
Chateaux



1:1



Per alimenti
Suitable for foodstuffs
Apte au contact avec les aliments
Für Lebensmittel
Apto para alimentos



Garantito per lavastoviglie
Dishwasher safe
Inalterable dans lave-vaisselle
Spelmaschinenfest
Apto para lavavajillas

Cod.	cm	Euro
0001	20,8	7,60
0002	21,1	7,60
0003	23,5	7,60
00CC	-	-
00CA	-	-
00L3	-	-
0067	-	-
0004	18,4	6,50
0005	18,4	6,50
0006	21,3	6,50
00L6	-	-
00CD	-	-
00CB	-	-
0007	15,5	4,95
0008	12,4	3,80
0010	27,2	24,30
0011	23,8	15,00
0012	24,0	15,00
0013	17,5	18,40
0014	-	-
0015	-	-
0016	-	-
0059	-	-
00AW	-	-
0017	16,4	4,83
0018	-	-
00L9	-	-
0019	-	-
0020	25,2	19,50
0052	-	-
00CR	-	-
0009	-	-
0022	-	-
0023	-	-
0025	-	-
00CS	-	-
0026	-	-
0027	-	-
00FM	-	-
0035	-	-
0036	-	-
0038	-	-
0039	18,2	5,93
00AT	-	-
0028	18,6	6,77
0029	20,6	6,77
0030	-	-
0031	-	-

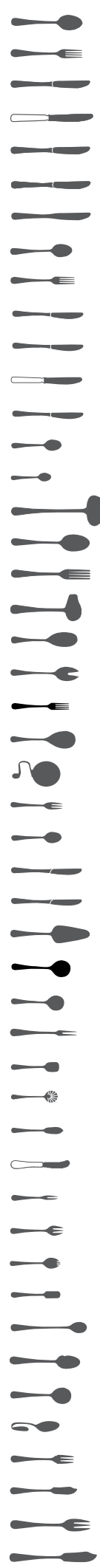

Bramante

Cod. 0780
PINTI1929®

inox 18/10
master 120 pcs
forgiato/forged



Ellade

Cod. 0790

PINTI1929®

inox 18/10
master 120 pcs
forgiato/forged



Cod.	cm	Euro
0001	21,2	8,50
0002	21,1	8,50
0003	24,0	8,50
00CC	-	-
00CA	-	-
00L3	-	-
0067	-	-
0004	18,7	6,50
0005	18,4	6,50
0006	21,7	6,50
00L6	-	-
00CD	-	-
00CB	-	-
0007	15,5	4,95
0008	12,5	3,80
0010	27,2	24,30
0011	24,4	15,00
0012	24,5	15,00
0013	18,9	18,40
0014	-	-
0015	-	-
0016	-	-
0059	-	-
00AW	-	-
0017	16,4	4,83
0018	-	-
00L9	-	-
0019	-	-
0020	24,6	19,50
0052	-	-
00CR	-	-
0009	-	-
0022	-	-
0023	-	-
0025	-	-
00CS	-	-
0026	-	-
0027	-	-
00FM	-	-
0035	-	-
0036	-	-
0038	-	-
0039	-	-
00AT	-	-
0028	18,6	8,50
0029	20,6	8,50
0030	-	-
0031	-	-

Cod.	cm	Euro
0001	21,0	3,90
0002	21,4	3,90
0003	23,0	6,30
00CC	-	-
00CA	-	-
00L3	-	-
0067	-	-
0004	18,5	3,20
0005	18,7	3,20
0006	21,0	5,45
00L6	-	-
00CD	-	-
00CB	-	-
0007	14,5	2,17
0008	12,5	1,98
0010	27,8	15,50
0011	23,6	7,50
0012	24,0	7,50
0013	18,5	9,00
0014	-	-
0015	-	-
0016	-	-
0059	-	-
00AW	-	-
0017	16,6	2,80
0018	-	-
00L9	-	-
0019	-	-
0020	26,0	11,50
0052	-	-
00CR	-	-
0009	-	-
0022	-	-
0023	-	-
0025	-	-
00CS	-	-
0026	-	-
0027	-	-
00FM	-	-
0035	-	-
0036	-	-
0038	-	-
0039	18,2	4,55
00AT	-	-
0028	18,9	3,50
0029	21,2	3,50
0030	-	-
0031	-	-

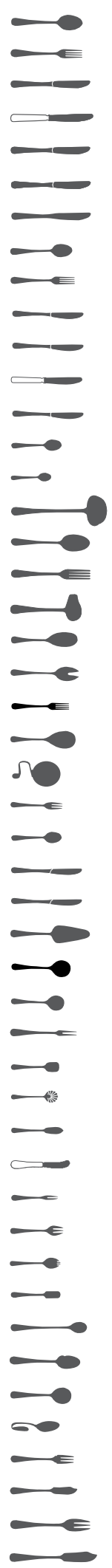

Privilege

Cod. 0510
PINTI1929[®]

inox 18/10
master 120 pcs
mm 4,0



Spaten

Cod. 1630

PINTI1929®

inox 18/10

master 120 pcs

mm 3,0



Cod.	cm	Euro
0001	20,9	3,75
0002	20,9	3,75
0003	24,0	7,25
00CC	24,5	13,50
00CA	-	-
00L3	-	-
0067	-	-
0004	18,8	3,45
0005	18,6	3,45
0006	21,15	7,15
00L6	-	-
00CD	21,15	12,20
00CB	-	-
0007	14,5	2,25
0008	12,0	1,98
0010	27,5	14,20
0011	24,2	7,10
0012	24,0	7,10
0013	17,8	10,60
0014	-	-
0015	-	-
0016	-	-
0059	-	-
00AW	-	-
0017	16,0	2,85
0018	-	-
00L9	-	-
0019	-	-
0020	24,8	10,75
0052	-	-
00CR	-	-
0009	-	-
0022	-	-
0023	-	-
0025	-	-
00CS	-	-
0026	-	-
0027	-	-
00FM	-	-
0035	-	-
0036	-	-
0038	-	-
0039	-	-
00AT	-	-
0028	18,7	3,75
0029	21,0	3,75
0030	-	-
0031	-	-

Cod.	cm	Euro
0001	20,9	3,75
0002	20,9	3,75
0003	24,0	7,25
00CC	24,5	13,50
00CA	-	-
00L3	-	-
0067	-	-
0004	18,8	3,45
0005	18,6	3,45
0006	21,5	7,15
00L6	-	-
00CD	21,5	12,20
00CB	-	-
0007	14,5	2,25
0008	12,0	1,98
0010	28,2	14,20
0011	24,2	7,10
0012	24,0	7,10
0013	17,8	10,60
0014	-	-
0015	-	-
0016	-	-
0059	-	-
00AW	-	-
0017	15,9	2,85
0018	-	-
00L9	-	-
0019	-	-
0020	24,8	10,75
0052	-	-
00CR	-	-
0009	-	-
0022	-	-
0023	-	-
0025	-	-
00CS	-	-
0026	-	-
0027	-	-
00FM	-	-
0035	-	-
0036	-	-
0038	-	-
0039	-	-
00AT	-	-
0028	18,7	3,75
0029	21,0	3,75
0030	-	-
0031	-	-

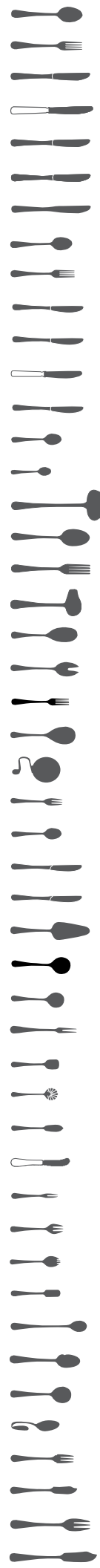

Vittoriale

Cod. 1640
PINTI1929®

inox 18/10
master 120 pcs
mm 3,0



Concept

Cod. 0450

PINTI1929®

inox 18/10
master 120 pcs
mm 3,0



Cod.	cm	Euro
0001	23,2	3,57
0002	23,2	3,57
0003	24,5	5,50
00CC	-	-
00CA	-	-
00L3	-	-
0067	-	-
0004	20,0	3,26
0005	20,1	3,26
0006	21,4	5,30
00L6	-	-
00CD	-	-
00CB	-	-
0007	17,2	2,42
0008	11,1	2,05
0010	29,0	15,50
0011	26,0	7,00
0012	26,0	7,00
0013	15,0	9,00
0014	-	-
0015	-	-
0016	-	-
0059	-	-
00AW	-	-
0017	17,2	2,78
0018	-	-
00L9	-	-
0019	-	-
0020	23,0	10,50
0052	-	-
00CR	-	-
0009	-	-
0022	-	-
0023	-	-
0025	-	-
00CS	-	-
0026	-	-
0027	-	-
00FM	-	-
0035	-	-
0036	-	-
0038	-	-
0039	-	-
00AT	-	-
0028	20,0	3,47
0029	22,2	3,47
0030	-	-
0031	-	-

Cod.	cm	Euro
0001	23,0	3,26
0002	23,0	3,26
0003	24,0	5,90
00CC	-	-
00CA	-	-
00L3	-	-
0067	-	-
0004	20,0	2,85
0005	19,9	2,85
0006	21,0	5,40
00L6	-	-
00CD	-	-
00CB	-	-
0007	17,0	2,25
0008	10,9	1,88
0010	29,0	18,75
0011	26,0	8,50
0012	26,0	8,50
0013	15,0	8,80
0014	-	-
0015	-	-
0016	-	-
0059	-	-
00AW	-	-
0017	17,0	2,63
0018	-	-
00L9	-	-
0019	-	-
0020	23,0	10,50
0052	-	-
00CR	15,0	2,20
0009	-	-
0022	-	-
0023	-	-
0025	-	-
00CS	-	-
0026	-	-
0027	-	-
00FM	-	-
0035	-	-
0036	-	-
0038	-	-
0039	-	-
00AT	-	-
0028	19,9	3,05
0029	21,8	3,05
0030	-	-
0031	-	-

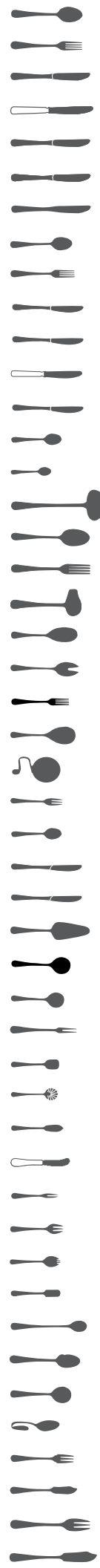

Tecna

Cod. 0470

PINTI1929®

inox 18/10
 master 120 pcs
 mm 3,0

Swing

Cod. 0880

PINTI1929®

inox 18/10

master 120 pcs

mm 3,0



Cod.	cm	Euro
0001	20,8	3,40
0002	20,9	3,40
0003	22,5	5,45
00CC	-	-
00CA	-	-
00L3	-	-
0067	-	-
0004	18,7	3,10
0005	18,7	3,10
0006	20,5	4,85
00L6	-	-
00CD	-	-
00CB	-	-
0007	14,6	1,95
0008	11,8	1,85
0010	28,0	15,40
0011	25,5	8,10
0012	25,5	8,10
0013	17,4	8,90
0014	-	-
0015	-	-
0016	-	-
0059	-	-
00AW	-	-
0017	15,4	2,49
0018	-	-
00L9	-	-
0019	-	-
0020	23,0	10,95
0052	-	-
00CR	-	-
0009	-	-
0022	-	-
0023	-	-
0025	-	-
00CS	-	-
0026	-	-
0027	-	-
00FM	-	-
0035	-	-
0036	-	-
0038	-	-
0039	-	-
00AT	-	-
0028	18,1	2,95
0029	19,8	2,95
0030	-	-
0031	-	-



Cod. 00FA cm 14,6
Cod. 00FB cm 18,7

Euro 1,99
Euro 2,60

cucch. antipasto piccolo *small starter spoon*
cucch. antipasto grande *large starter spoon*

Cod.	cm	Euro
0001	23,0	3,15
0002	23,0	3,15
0003	24,5	5,25
00CC	-	-
00CA	-	-
00L3	-	-
0067	-	-
0004	19,8	2,90
0005	19,7	2,90
0006	21,4	4,65
00L6	-	-
00CD	-	-
00CB	-	-
0007	16,5	2,10
0008	11,0	1,87
0010	29,0	17,50
0011	26,0	8,50
0012	26,0	8,50
0013	14,9	8,80
0014	26,0	9,25
0015	26,0	9,25
0016	-	-
0059	-	-
00AW	-	-
0017	17,0	2,56
0018	-	-
00L9	-	-
0019	-	-
0020	23,1	10,95
0052	-	-
00CR	-	-
0009	-	-
0022	-	-
0023	-	-
0025	-	-
00CS	-	-
0026	-	-
0027	-	-
00FM	-	-
0035	-	-
0036	-	-
0038	-	-
0039	-	-
00AT	-	-
0028	19,7	2,90
0029	21,8	2,90
0030	-	-
0031	-	-

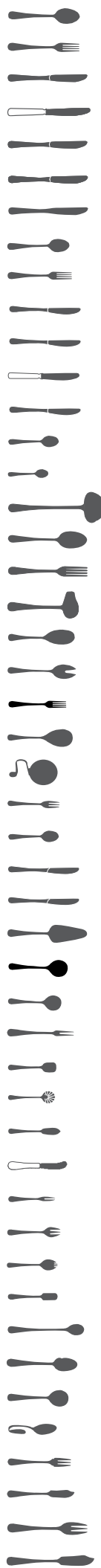

Olivia

Cod. 0490

PINTI1929®

inox 18/10
master 120 pcs
mm 3,0

Baguette

Cod. 0830

PINTI1929[®]

inox 18/10

master 120 pcs

mm 3,0



Cod.	cm	Euro
0001	20,6	3,45
0002	20,6	3,45
0003	24,1	5,90
00CC	25,3	12,90
00CA	-	-
00L3	-	-
0067	23,0	5,90
0004	17,8	3,10
0005	18,5	3,10
0006	22,0	5,65
00L6	-	-
00CD	22,5	11,50
00CB	-	-
0007	14,6	1,95
0008	11,8	1,85
0010	28,0	14,50
0011	23,5	7,00
0012	23,6	7,00
0013	17,5	8,00
0014	-	-
0015	-	-
0016	-	-
0059	-	-
00AW	-	-
0017	15,1	2,50
0018	-	-
00L9	-	-
0019	17,7	3,90
0020	24,0	9,35
0052	-	-
00CR	-	-
0009	-	-
0022	-	-
0023	-	-
0025	-	-
00CS	-	-
0026	-	-
0027	-	-
00FM	-	-
0035	-	-
0036	-	-
0038	20,4	3,50
0039	17,9	3,50
00AT	-	-
0028	18,0	3,15
0029	19,4	3,15
0030	23,0	7,00
0031	25,0	7,00

Cod.	cm	Euro
0001	20,6	3,45
0002	20,6	3,45
0003	24,0	5,90
00CC	25,2	12,90
00CA	-	-
00L3	-	-
0067	22,8	5,90
0004	17,9	3,10
0005	18,5	3,10
0006	21,6	5,65
00L6	-	-
00CD	21,6	11,50
00CB	-	-
0007	14,6	1,95
0008	11,8	1,85
0010	28,0	14,50
0011	23,5	7,00
0012	23,8	7,00
0013	17,9	8,00
0014	-	-
0015	22,8	7,90
0016	-	-
0059	-	-
00AW	-	-
0017	15,0	2,50
0018	-	-
00L9	-	-
0019	17,6	3,90
0020	24,0	9,35
0052	-	-
00CR	15,2	3,10
0009	19,7	3,52
0022	13,6	1,94
0023	13,5	2,31
0025	15,0	2,57
00CS	-	-
0026	15,3	2,35
0027	15,5	3,10
00FM	-	-
0035	12,1	2,57
0036	22,0	2,95
0038	20,4	3,50
0039	17,8	3,50
00AT	-	-
0028	18,0	3,15
0029	19,6	3,15
0030	22,5	7,00
0031	25,0	7,00

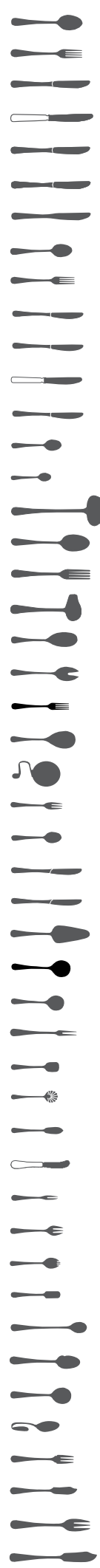

Byron

Cod. 0800

PINTI1929®

inox 18/10
master 120 pcs
mm 3,0



Palladium

Cod. 0590

PINTI1929®

inox 18/10

master 120 pcs

mm 3,0



Cod.	cm	Euro
0001	20,8	3,45
0002	20,6	3,45
0003	23,6	5,90
00CC	24,9	12,90
00CA	-	-
00L3	-	-
0067	-	-
0004	18,1	3,10
0005	18,2	3,10
0006	21,2	5,65
00L6	-	-
00CD	14,6	11,50
00CB	-	-
0007	14,6	1,95
0008	11,0	1,85
0010	27,2	14,50
0011	24,1	7,00
0012	24,0	7,00
0013	17,0	8,00
0014	-	-
0015	-	-
0016	-	-
0059	-	-
00AW	-	-
0017	15,5	2,50
0018	-	-
00L9	-	-
0019	-	-
0020	24,0	9,35
0052	-	-
00CR	-	-
0009	-	-
0022	-	-
0023	-	-
0025	-	-
00CS	-	-
0026	-	-
0027	-	-
00FM	-	-
0035	-	-
0036	-	-
0038	-	-
0039	-	-
00AT	-	-
0028	18,8	3,15
0029	20,1	3,15
0030	-	-
0031	-	-

Cod.	cm	Euro
0001	20,4	3,45
0002	20,6	3,45
0003	23,2	5,90
00CC	24,5	12,90
00CA	-	-
00L3	-	-
0067	-	-
0004	17,7	3,10
0005	18,4	3,10
0006	21,0	5,65
00L6	-	-
00CD	21,3	11,50
00CB	-	-
0007	14,5	1,95
0008	11,9	1,85
0010	27,7	14,50
0011	23,5	7,00
0012	23,7	7,00
0013	17,4	8,00
0014	-	-
0015	22,8	7,90
0016	-	-
0059	-	-
00AW	-	-
0017	15,0	2,50
0018	-	-
00L9	-	-
0019	17,7	3,90
0020	24,0	9,35
0052	-	-
00CR	15,5	3,10
0009	19,5	3,52
0022	13,6	1,94
0023	13,5	2,31
0025	15,0	2,57
00CS	-	-
0026	15,4	2,35
0027	15,5	3,10
00FM	12,5	2,35
0035	12,0	2,57
0036	22,0	2,95
0038	20,4	3,50
0039	17,7	3,50
00AT	-	-
0028	17,8	3,15
0029	19,5	3,15
0030	22,6	7,00
0031	25,1	7,00

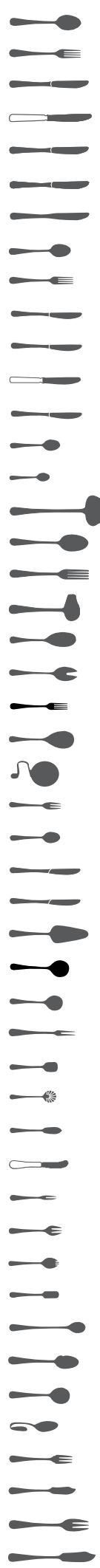

Pitagora

Cod. 0810

PINTI1929®

inox 18/10
master 120 pcs
mm 3,0



Cod. 07600067 cm 23,0 Euro 5,90 colt. bist. profess. *profess. meat knife.*

Leonardo

Cod. 0500

PINTI1929®

inox 18/10

master 120 pcs

mm 3,0



Cod.	cm	Euro
0001	20,8	3,45
0002	20,7	3,45
0003	24,0	5,90
00CC	23,8	12,90
00CA	-	-
00L3	-	-
0067	23,0	5,90
0004	17,5	3,10
0005	17,7	3,10
0006	21,5	5,65
00L6	-	-
00CD	20,6	11,50
00CB	-	-
0007	14,5	1,95
0008	11,8	1,85
0010	28,0	14,50
0011	23,5	7,00
0012	23,8	7,00
0013	18,0	8,00
0014	-	-
0015	23,0	7,90
0016	-	-
0059	-	-
00AW	-	-
0017	16,7	2,50
0018	-	-
00L9	-	-
0019	-	-
0020	23,2	9,35
0052	-	-
00CR	-	-
0009	-	-
0022	-	-
0023	-	-
0025	-	-
00CS	-	-
0026	-	-
0027	-	-
00FM	-	-
0035	-	-
0036	-	-
0038	-	-
0039	-	-
00AT	-	-
0028	19,5	3,15
0029	21,3	3,15
0030	-	-
0031	-	-

Cod.	cm	Euro
0001	20,8	3,60
0002	20,8	3,60
0003	23,5	4,50
00CC	23,8	12,90
00CA	-	-
00L3	-	-
0067	23,6	4,50
0004	18,7	3,20
0005	18,7	3,20
0006	21,15	4,25
00L6	-	-
00CD	21,5	11,50
00CB	-	-
0007	14,7	2,25
0008	10,7	1,75
0010	27,4	15,50
0011	23,5	8,00
0012	23,8	8,00
0013	17,6	8,50
0014	-	-
0015	-	-
0016	-	-
0059	-	-
00AW	-	-
0017	15,5	2,26
0018	-	-
00L9	-	-
0019	-	-
0020	23,5	11,10
0052	-	-
00CR	-	-
0009	-	-
0022	-	-
0023	-	-
0025	-	-
00CS	-	-
0026	-	-
0027	-	-
00FM	-	-
0035	-	-
0036	-	-
0038	-	-
0039	-	-
00AT	-	-
0028	18,7	2,90
0029	19,8	2,90
0030	-	-
0031	-	-

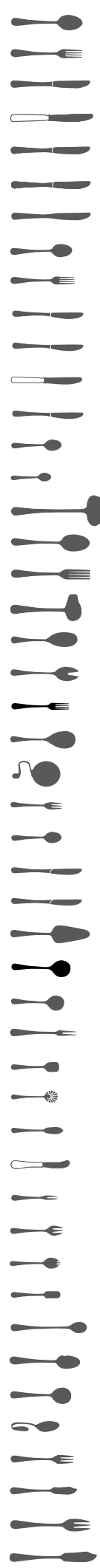

Millenium

Cod. 2270

PINTINOX

inox 18/10
master 120 pcs
mm 4,0

Ritz

Cod. 2280

PINTINOX

inox 18/10

master 120 pcs

mm 4,0



Cod.	cm	Euro
0001	20,8	3,60
0002	20,8	3,60
0003	23,5	4,50
00CC	24,0	12,90
00CA	-	-
00L3	-	-
0067	22,8	4,50
0004	17,8	3,20
0005	18,1	3,20
0006	21,15	4,25
00L6	-	-
00CD	21,5	11,50
00CB	-	-
0007	14,3	2,25
0008	11,1	1,75
0010	27,5	15,50
0011	24,0	8,00
0012	24,0	8,00
0013	17,0	8,50
0014	-	-
0015	-	-
0016	-	-
0059	-	-
00AW	-	-
0017	14,8	2,26
0018	-	-
00L9	-	-
0019	-	-
0020	23,6	11,10
0052	-	-
00CR	-	-
0009	-	-
0022	-	-
0023	-	-
0025	-	-
00CS	-	-
0026	-	-
0027	-	-
00FM	-	-
0035	-	-
0036	-	-
0038	-	-
0039	-	-
00AT	-	-
0028	19,0	2,90
0029	19,7	2,90
0030	-	-
0031	-	-

Cod.	cm	Euro
0001	21,0	2,75
0002	20,9	2,75
0003	23,0	3,95
00CC	-	-
00CA	-	-
00L3	-	-
0067	23,0	3,95
0004	-	-
0005	18,0	2,40
0006	21,0	3,85
00L6	-	-
00CD	-	-
00CB	-	-
0007	15,0	1,71
0008	11,0	1,64
0010	29,0	14,50
0011	25,0	6,50
0012	25,0	6,50
0013	-	-
0014	-	-
0015	-	-
0016	-	-
0059	-	-
00AW	-	-
0017	-	-
0018	-	-
00L9	-	-
0019	-	-
0020	-	-
0052	-	-
00CR	-	-
0009	-	-
0022	-	-
0023	-	-
0025	-	-
00CS	-	-
0026	-	-
0027	-	-
00FM	-	-
0035	-	-
0036	-	-
0038	-	-
0039	-	-
00AT	-	-
0028	20,0	2,55
0029	22,0	2,55
0030	-	-
0031	-	-

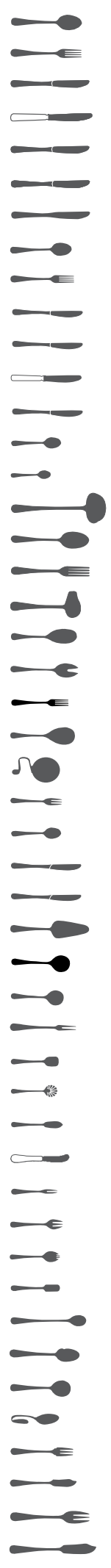

Carlton

Cod. 1780

PINTINOX

inox 18/10
 master 120 pcs
 mm 3,0

Settecento

Cod. 2050

PINTINOX

inox 18/10
master 120 pcs
mm 3,0



Cod.	cm	Euro
0001	20,1	3,00
0002	20,1	3,00
0003	22,7	3,95
00CC	25,0	12,90
00CA	-	-
00L3	-	-
0067	-	-
0004	17,1	2,60
0005	17,1	2,60
0006	20,2	3,85
00L6	-	-
00CD	22,5	11,50
00CB	-	-
0007	14,6	1,75
0008	11,8	1,60
0010	28,0	14,50
0011	23,1	6,50
0012	23,6	6,50
0013	16,5	7,50
0014	-	-
0015	-	-
0016	-	-
0059	-	-
00AW	-	-
0017	14,8	1,83
0018	-	-
00L9	-	-
0019	-	-
0020	22,7	9,20
0052	-	-
00CR	-	-
0009	-	-
0022	-	-
0023	-	-
0025	-	-
00CS	-	-
0026	-	-
0027	-	-
00FM	-	-
0035	-	-
0036	-	-
0038	-	-
0039	-	-
00AT	-	-
0028	19,4	2,80
0029	20,9	2,80
0030	-	-
0031	-	-

Cod.	cm	Euro
0001	20,8	3,27
0002	20,8	3,27
0003	23,0	5,90
00CC	-	-
00CA	-	-
00L3	-	-
0067	-	-
0004	18,7	2,55
0005	18,7	2,55
0006	21,15	5,65
00L6	-	-
00CD	-	-
00CB	-	-
0007	14,4	1,71
0008	11,6	1,49
0010	29,0	13,50
0011	24,0	5,70
0012	23,5	5,70
0013	18,8	6,50
0014	-	-
0015	-	-
0016	-	-
0059	-	-
00AW	-	-
0017	15,3	1,79
0018	-	-
00L9	-	-
0019	-	-
0020	24,0	6,80
0052	-	-
00CR	-	-
0009	-	-
0022	-	-
0023	-	-
0025	-	-
00CS	-	-
0026	-	-
0027	-	-
00FM	-	-
0035	-	-
0036	-	-
0038	-	-
0039	-	-
00AT	-	-
0028	18,7	2,65
0029	19,8	2,65
0030	-	-
0031	-	-

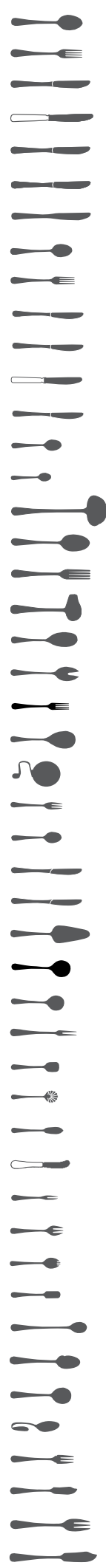

Romanino

Cod. 0650

PINTINOX

inox 18/10
master 120 pcs
mm 3,5



Savoy

Cod. 1700

PINTINOX

inox 18/10
 master 120 pcs
 mm 3,0



Cod.	cm	Euro
0001	20,8	2,85
0002	20,9	2,85
0003	23,0	3,95
00CC	-	-
00CA	-	-
00L3	-	-
0067	-	-
0004	18,0	2,50
0005	18,1	2,50
0006	20,0	3,85
00L6	-	-
00CD	-	-
00CB	-	-
0007	14,9	1,65
0008	11,0	1,60
0010	28,0	15,90
0011	25,5	7,10
0012	25,5	7,10
0013	17,4	7,50
0014	-	-
0015	-	-
0016	-	-
0059	-	-
00AW	-	-
0017	16,1	1,95
0018	-	-
00L9	-	-
0019	-	-
0020	23,0	9,00
0052	-	-
00CR	-	-
0009	-	-
0022	-	-
0023	-	-
0025	-	-
00CS	-	-
0026	-	-
0027	-	-
00FM	-	-
0035	-	-
0036	-	-
0038	-	-
0039	-	-
00AT	-	-
0028	18,1	2,60
0029	20,0	2,60
0030	-	-
0031	-	-

Cod.	cm	Euro
0001	21,2	2,95
0002	21,0	2,95
0003	23,0	5,65
00CC	-	-
00CA	-	-
00L3	-	-
0067	-	-
0004	18,1	2,70
0005	18,0	2,70
0006	20,0	4,70
00L6	-	-
00CD	-	-
00CB	-	-
0007	15,1	2,00
0008	11,1	1,64
0010	29,0	19,80
0011	24,0	6,85
0012	24,0	6,85
0013	16,5	8,10
0014	-	-
0015	-	-
0016	-	-
0059	-	-
00AW	-	-
0017	17,0	2,57
0018	-	-
00L9	-	-
0019	-	-
0020	24,0	8,60
0052	-	-
00CR	-	-
0009	-	-
0022	-	-
0023	-	-
0025	-	-
00CS	-	-
0026	-	-
0027	-	-
00FM	-	-
0035	-	-
0036	-	-
0038	-	-
0039	-	-
00AT	-	-
0028	19,5	2,90
0029	21,5	2,90
0030	-	-
0031	-	-

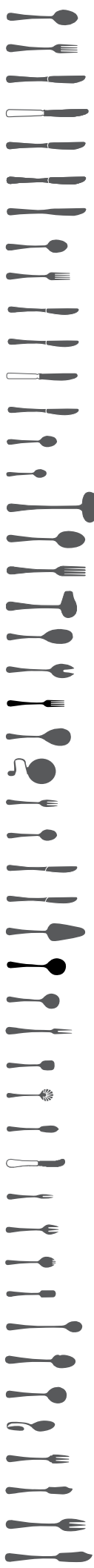

Liberty

Cod. 1660

PINTINOX

inox 18/10
 master 120 pcs
 mm 3,0

Palace

Cod. 1690

PINTINOX

inox 18/10

master 120 pcs

mm 3,0



Cod.	cm	Euro
0001	21,0	2,85
0002	21,0	2,85
0003	23,4	3,95
00CC	-	-
00CA	-	-
00L3	-	-
0067	22,0	3,95
0004	18,2	2,50
0005	18,2	2,50
0006	21,0	3,85
00L6	-	-
00CD	-	-
00CB	-	-
0007	14,7	1,79
0008	10,8	1,52
0010	28,8	15,90
0011	24,1	7,10
0012	24,1	7,10
0013	14,0	7,50
0014	-	-
0015	25,0	7,50
0016	-	-
0059	-	-
00AW	-	-
0017	14,6	1,95
0018	-	-
00L9	-	-
0019	-	-
0020	22,9	7,50
0052	-	-
00CR	-	-
0009	-	-
0022	14,5	1,85
0023	-	-
0025	18,0	2,60
00CS	-	-
0026	-	-
0027	14,5	2,10
00FM	-	-
0035	-	-
0036	22,0	2,25
0038	21,5	3,12
0039	18,5	3,12
00AT	-	-
0028	18,2	2,55
0029	20,3	2,55
0030	-	-
0031	-	-

Cod.	cm	Euro
0001	19,5	2,78
0002	19,5	2,78
0003	21,6	3,50
00CC	-	-
00CA	-	-
00L3	-	-
0067	-	-
0004	16,6	2,35
0005	16,6	2,35
0006	19,8	3,15
00L6	-	-
00CD	-	-
00CB	-	-
0007	13,8	1,67
0008	11,6	1,30
0010	27,0	13,80
0011	22,8	6,50
0012	22,8	6,50
0013	16,7	7,45
0014	-	-
0015	-	-
0016	-	-
0059	-	-
00AW	-	-
0017	14,6	1,83
0018	-	-
00L9	-	-
0019	-	-
0020	23,2	9,20
0052	-	-
00CR	-	-
0009	-	-
0022	-	-
0023	-	-
0025	-	-
00CS	-	-
0026	-	-
0027	-	-
00FM	-	-
0035	-	-
0036	-	-
0038	-	-
0039	-	-
00AT	-	-
0028	19,2	2,66
0029	20,7	2,66
0030	-	-
0031	-	-

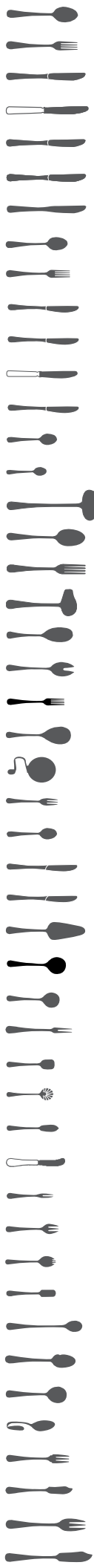

Casali

Cod. 2100

PINTINOX

inox 18/10
 master 120 pcs
 mm 3,0



Trend

Cod. 1670

PINTINOX

inox 18/10
master 120 pcs
mm 3,0



Cod.	cm	Euro
0001	21,2	2,70
0002	21,2	2,70
0003	23,0	4,90
00CC	-	-
00CA	-	-
00L3	-	-
0067	-	-
0004	18,0	2,50
0005	18,0	2,50
0006	20,0	4,50
00L6	-	-
00CD	-	-
00CB	-	-
0007	15,0	1,67
0008	11,0	1,56
0010	28,6	17,50
0011	24,0	7,20
0012	24,0	7,20
0013	16,4	9,70
0014	-	-
0015	-	-
0016	-	-
0059	-	-
00AW	-	-
0017	16,1	1,98
0018	-	-
00L9	-	-
0019	-	-
0020	24,3	9,85
0052	-	-
00CR	-	-
0009	-	-
0022	-	-
0023	-	-
0025	-	-
00CS	-	-
0026	-	-
0027	-	-
00FM	-	-
0035	-	-
0036	-	-
0038	-	-
0039	-	-
00AT	-	-
0028	18,0	2,52
0029	19,9	2,52
0030	-	-
0031	-	-

Cod.	cm	Euro
0001	21,0	2,50
0002	21,2	2,50
0003	22,5	3,80
00CC	-	-
00CA	-	-
00L3	-	-
0067	22,5	3,80
0004	18,3	2,30
0005	18,2	2,30
0006	20,1	3,60
00L6	-	-
00CD	-	-
00CB	-	-
0007	14,8	1,55
0008	10,9	1,30
0010	26,9	16,00
0011	24,9	7,00
0012	25,1	7,00
0013	16,4	8,50
0014	-	-
0015	-	-
0016	-	-
0059	-	-
00AW	-	-
0017	16,1	1,65
0018	-	-
00L9	-	-
0019	-	-
0020	22,8	8,50
0052	-	-
00CR	-	-
0009	-	-
0022	-	-
0023	-	-
0025	-	-
00CS	-	-
0026	-	-
0027	-	-
00FM	-	-
0035	-	-
0036	22,1	2,55
0038	-	-
0039	-	-
00AT	-	-
0028	18,5	2,50
0029	20,7	2,50
0030	-	-
0031	-	-

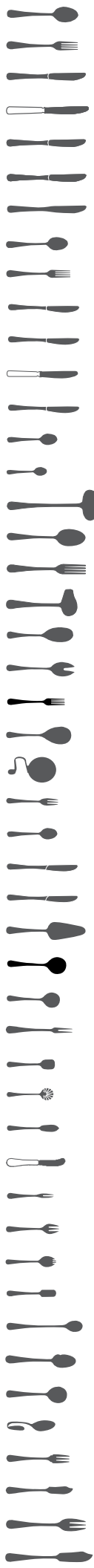

Synthesis

Cod. 2030

PINTINOX

inox 18/10
master 120 pcs
mm 3,0



Synthesis Cod. 2030



Cod. 0011
cm 24,9
cucchiaione servire
serving spoon



Cod. 0012
cm 25,1
forchettone servire
serving fork



Cod. 0003
cm 22,5
coltello tavola
table knife



Cod. 0036
cm 22,1
cucchiaino bibita
long drink spoon



Cod. 0002
cm 21,2
forchetta tavola
table fork



Cod. 0067
cm 22,5
coltello bistecca
steak knife



Cod. 0001
cm 21,0
cucchiaio tavola
table spoon



Cod. 0028
cm 18,5
forchetta pesce
fish fork



Cod. 0029
cm 20,7
coltello pesce
fish knife



Cod. 0004
cm 18,3
cucchiaio frutta
dessert spoon



Cod. 0005
cm 18,2
forchetta frutta
dessert fork



Cod. 0006
cm 20,1
coltello frutta
dessert knife



Cod. 0007
cm 14,8
cucchiaino caffè
tea/coffee spoon



Cod. 0017
cm 16,1
forchetta dolce
pastry fork



Cod. 0008
cm 10,9
cucchiaino moka
moka spoon



Cod. 0010
cm 26,9
mestolo
soup ladle



Cod. 0020
cm 22,8
pala torta
cake server



Cod. 0013
cm 16,4
mestolo salsa
sauce ladle

Cod. cm Euro

0001 19,7 2,55

0002 20,0 2,55

0003 21,5 3,80

00CC - -

00CA - -

00L3 - -

0067 - -

0004 18,1 2,25

0005 17,6 2,25

0006 18,4 3,60

00L6 - -

00CD - -

00CB - -

0007 13,8 1,60

0008 12,1 1,25

0010 27,2 14,00

0011 22,3 6,50

0012 22,4 6,50

0013 17,8 8,15

0014 - -

0015 - -

0016 - -

0059 - -

00AW - -

0017 15,7 1,70

0018 - -

00L9 - -

0019 - -

0020 23,6 7,25

0052 - -

00CR - -

0009 - -

0022 - -

0023 - -

0025 - -

00CS - -

0026 - -

0027 - -

00FM - -

0035 - -

0036 - -

0038 - -

0039 - -

00AT - -

0028 19,1 2,30

0029 19,4 2,30

0030 - -

0031 - -



Solaris

Cod. 2170

PINTINOX

inox 18/10
master 120 pcs
mm 2,5

Sirio

Cod. 2260

PINTINOX

inox 18/10
master 120 pcs
mm 2,5



Cod.	cm	Euro
0001	20,6	2,60
0002	20,6	2,60
0003	24,1	4,45
00CC	25,0	12,90
00CA	-	-
00L3	-	-
0067	-	-
0004	18,5	2,30
0005	18,5	2,30
0006	22,0	3,90
00L6	-	-
00CD	22,0	11,50
00CB	-	-
0007	14,6	1,69
0008	11,6	1,25
0010	27,2	14,50
0011	23,2	6,50
0012	23,6	6,50
0013	17,5	9,00
0014	-	-
0015	22,3	7,00
0016	14,7	1,80
0059	-	-
00AW	-	-
0017	-	-
0018	-	-
00L9	-	-
0019	17,77	3,20
0020	23,7	7,50
0052	-	-
00CR	-	-
0009	-	-
0022	13,7	1,65
0023	-	-
0025	-	-
00CS	-	-
0026	-	-
0027	-	-
00FM	-	-
0035	-	-
0036	-	-
0038	-	-
0039	-	-
00AT	-	-
0028	18,0	2,30
0029	19,4	2,30
0030	22,7	6,50
0031	25,1	6,50

Cod.	cm	Euro
0001	20,6	2,60
0002	20,6	2,60
0003	24,1	4,45
00CC	-	-
00CA	-	-
00L3	-	-
0067	-	-
0004	18,5	2,30
0005	18,5	2,30
0006	22,0	3,90
00L6	-	-
00CD	-	-
00CB	-	-
0007	14,6	1,69
0008	11,8	1,25
0010	28,0	14,50
0011	23,5	6,50
0012	23,6	6,50
0013	17,5	9,00
0014	-	-
0015	-	-
0016	-	-
0059	-	-
00AW	-	-
0017	15,1	1,80
0018	-	-
00L9	-	-
0019	-	-
0020	24,0	7,50
0052	-	-
00CR	-	-
0009	-	-
0022	-	-
0023	-	-
0025	-	-
00CS	-	-
0026	-	-
0027	-	-
00FM	-	-
0035	-	-
0036	-	-
0038	-	-
0039	-	-
00AT	-	-
0028	18,0	2,30
0029	19,4	2,30
0030	-	-
0031	-	-

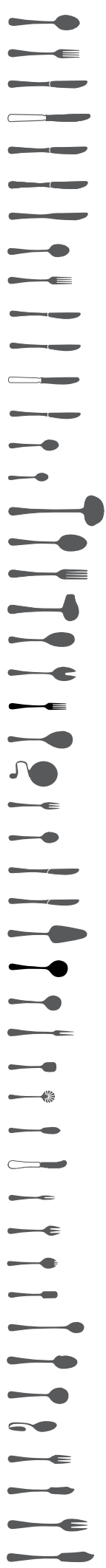

Roma

Cod. 2200

PINTINOX

inox 18/10
master 120 pcs
mm 2,5



Expo

Cod. 2040

PINTINOX

inox 18/10

master 120 pcs

mm 2,5



Cod.	cm	Euro
0001	20,6	2,75
0002	20,9	2,75
0003	24,3	3,95
00CC	-	-
00CA	-	-
00L3	-	-
0067	-	-
0004	28,5	2,30
0005	18,9	2,30
0006	21,4	3,85
00L6	-	-
00CD	-	-
00CB	-	-
0007	15,0	1,75
0008	11,6	1,20
0010	-	-
0011	-	-
0012	-	-
0013	-	-
0014	-	-
0015	-	-
0016	-	-
0059	-	-
00AW	-	-
0017	15,2	1,83
0018	-	-
00L9	-	-
0019	-	-
0020	-	-
0052	-	-
00CR	-	-
0009	-	-
0022	-	-
0023	-	-
0025	-	-
00CS	-	-
0026	-	-
0027	-	-
00FM	-	-
0035	-	-
0036	-	-
0038	-	-
0039	-	-
00AT	-	-
0028	18,9	2,50
0029	19,7	2,50
0030	-	-
0031	-	-

Cod. cm Euro

0001 20,6 2,60

0002 20,9 2,60

0003 22,6 4,45

00CC - -

00CA - -

00L3 - -

0067 22,5 4,45

0004 18,3 2,35

0005 18,5 2,35

0006 19,9 3,90

00L6 - -

00CD - -

00CB - -

0007 15,1 1,75

0008 11,6 1,20

0010 29,3 14,50

0011 25,3 6,50

0012 23,5 6,50

0013 17,1 9,00

0014 - -

0015 - -

0016 - -

0059 - -

00AW - -

0017 15,3 1,83

0018 - -

00L9 - -

0019 - -

0020 23,9 7,50

0052 - -

00CR - -

0009 - -

0022 - -

0023 - -

0025 - -

00CS - -

0026 - -

0027 - -

00FM - -

0035 - -

0036 - -

0038 - -

0039 - -

00AT - -

0028 18,6 2,50

0029 19,6 2,50

0030 - -

0031 - -

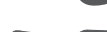

Sabrina

Cod. 2090

PINTINOX

inox 18/10
master 120 pcs
mm 2,5



Maitre

Cod. 2010

PINTINOX

inox 18/10
 master 120 pcs
 mm 2,5



Cod.	cm	Euro
0001	20,8	2,40
0002	20,8	2,40
0003	23,0	3,95
00CC	-	-
00CA	-	-
00L3	-	-
0067	-	-
0004	17,9	2,20
0005	17,9	2,20
0006	20,0	3,80
00L6	-	-
00CD	-	-
00CB	-	-
0007	14,9	1,57
0008	11,0	1,52
0010	28,0	14,50
0011	25,3	6,90
0012	25,3	6,90
0013	16,5	7,50
0014	-	-
0015	-	-
0016	-	-
0059	-	-
00AW	-	-
0017	16,0	1,70
0018	-	-
00L9	-	-
0019	-	-
0020	22,7	8,90
0052	-	-
00CR	-	-
0009	-	-
0022	-	-
0023	-	-
0025	-	-
00CS	-	-
0026	-	-
0027	-	-
00FM	-	-
0035	-	-
0036	-	-
0038	-	-
0039	-	-
00AT	-	-
0028	17,9	2,50
0029	20,1	2,50
0030	-	-
0031	-	-

Cod.	cm	Euro
0001	19,6	2,20
0002	19,4	2,20
0003	22,2	3,60
00CC	-	-
00CA	-	-
00L3	-	-
0067	-	-
0004	17,8	2,00
0005	17,4	2,00
0006	19,6	3,50
00L6	-	-
00CD	-	-
00CB	-	-
0007	13,4	1,52
0008	11,5	1,15
0010	26,2	14,00
0011	22,7	5,50
0012	23,2	5,50
0013	17,1	7,00
0014	-	-
0015	-	-
0016	-	-
0059	-	-
00AW	-	-
0017	14,4	1,65
0018	-	-
00L9	-	-
0019	-	-
0020	23,2	11,60
0052	-	-
00CR	-	-
0009	-	-
0022	-	-
0023	-	-
0025	-	-
00CS	-	-
0026	-	-
0027	-	-
00FM	-	-
0035	-	-
0036	-	-
0038	-	-
0039	-	-
00AT	-	-
0028	18,3	2,35
0029	19,7	2,35
0030	-	-
0031	-	-

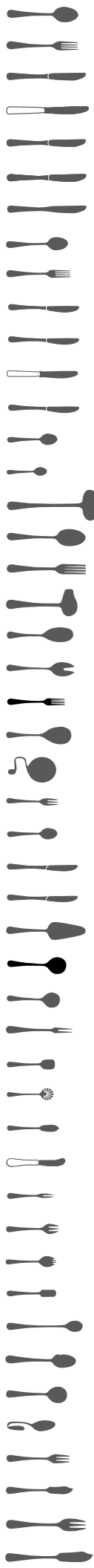

Bristol

Cod. 2140

PINTINOX

inox 18/10
 master 120 pcs
 mm 2,5



America

Cod. 2240

PINTINOX

inox 18/10
master 120 pcs
mm 2,5



Cod.	cm	Euro
0001	19,5	2,10
0002	19,5	2,10
0003	21,0	3,30
00CC	-	-
00CA	-	-
00L3	-	-
0067	-	-
0004	17,8	1,90
0005	17,1	1,90
0006	18,7	3,10
00L6	-	-
00CD	-	-
00CB	-	-
0007	13,3	1,17
0008	11,6	1,08
0010	28,0	13,50
0011	22,0	6,00
0012	22,3	6,00
0013	16,8	7,50
0014	-	-
0015	-	-
0016	-	-
0059	-	-
00AW	-	-
0017	15,9	1,65
0018	-	-
00L9	-	-
0019	-	-
0020	24,0	7,50
0052	-	-
00CR	-	-
0009	-	-
0022	13,1	1,52
0023	-	-
0025	-	-
00CS	-	-
0026	-	-
0027	-	-
00FM	-	-
0035	-	-
0036	22,0	2,00
0038	-	-
0039	-	-
00AT	-	-
0028	18,9	2,30
0029	22,2	2,30
0030	22,3	6,50
0031	24,5	6,50

Cod. cm Euro

0001 19,3 2,15

0002 19,4 2,15

0003 21,1 3,30

00CC - -

00CA - -

00L3 - -

0067 - -

0004 17,8 1,95

0005 16,6 1,95

0006 18,0 3,10

00L6 - -

00CD - -

00CB - -

0007 13,2 1,25

0008 11,6 1,15

0010 27,2 17,50

0011 22,2 6,00

0012 22,1 6,00

0013 16,0 7,50

0014 - -

0015 - -

0016 - -

0059 - -

00AW - -

0017 15,5 1,65

0018 - -

00L9 - -

0019 - -

0020 23,0 7,50

0052 - -

00CR - -

0009 - -

0022 - -

0023 - -

0025 - -

00CS - -

0026 - -

0027 - -

00FM - -

0035 - -

0036 - -

0038 - -

0039 - -

00AT - -

0028 17,7 2,15

0029 18,6 2,15

0030 - -

0031 - -

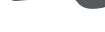

Hotel

Cod. 2020

PINTINOX

inox 18/10
master 120 pcs
mm 2,5

Gamma

Cod. 2150

PINTINOX

inox 18/10
master 120 pcs
mm 2,5



Cod.	cm	Euro
0001	19,6	1,95
0002	19,6	1,95
0003	21,0	3,30
00CC	-	-
00CA	-	-
00L3	-	-
0067	-	-
0004	17,8	1,70
0005	17,9	1,70
0006	19,1	3,10
00L6	-	-
00CD	-	-
00CB	-	-
0007	13,7	1,52
0008	12,3	1,06
0010	27,5	13,50
0011	22,0	5,50
0012	22,4	5,50
0013	18,0	7,50
0014	-	-
0015	-	-
0016	-	-
0059	-	-
00AW	-	-
0017	15,9	1,40
0018	-	-
00L9	-	-
0019	-	-
0020	21,7	8,50
0052	-	-
00CR	-	-
0009	-	-
0022	13,6	1,56
0023	-	-
0025	-	-
00CS	-	-
0026	-	-
0027	-	-
00FM	-	-
0035	-	-
0036	22,0	2,10
0038	-	-
0039	-	-
00AT	-	-
0028	19,8	2,25
0029	22,3	2,25
0030	-	-
0031	-	-

Cod.	cm	Euro
0001	19,7	2,15
0002	19,3	2,15
0003	21,2	3,30
00CC	-	-
00CA	-	-
00L3	-	-
0067	-	-
0004	18,6	1,99
0005	17,4	1,99
0006	19,9	3,10
00L6	-	-
00CD	-	-
00CB	-	-
0007	13,8	1,10
0008	11,8	1,00
0010	26,9	13,50
0011	21,9	6,50
0012	22,5	6,50
0013	17,6	7,00
0014	-	-
0015	-	-
0016	-	-
0059	-	-
00AW	-	-
0017	17,5	1,25
0018	-	-
00L9	-	-
0019	-	-
0020	21,6	8,50
0052	-	-
00CR	-	-
0009	-	-
0022	-	-
0023	-	-
0025	-	-
00CS	-	-
0026	-	-
0027	-	-
00FM	-	-
0035	-	-
0036	-	-
0038	-	-
0039	-	-
00AT	-	-
0028	19,1	2,15
0029	20,6	2,15
0030	-	-
0031	-	-

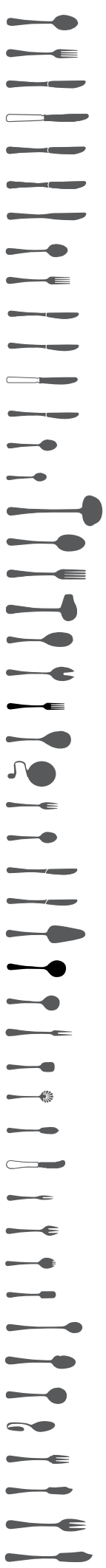

Ischia

Cod. 2250

PINTINOX

inox 18/10
 master 120 pcs
 mm 2,5



Tema

Cod. 2120

PINTINOX

inox 18/10
master 120 pcs
mm 2,5



Cod.	cm	Euro
0001	19,6	1,90
0002	19,8	1,90
0003	21,2	3,30
00CC	-	-
00CA	-	-
00L3	21,4	2,15
0067	-	-
0004	17,0	1,49
0005	17,1	1,49
0006	19,1	3,10
00L6	19,5	1,99
00CD	-	-
00CB	-	-
0007	14,8	1,10
0008	11,2	0,91
0010	27,7	12,90
0011	22,3	5,50
0012	22,7	5,50
0013	17,6	6,90
0014	-	-
0015	-	-
0016	14,9	1,15
0059	-	-
00AW	-	-
0017	-	-
0018	-	-
00L9	-	-
0019	-	-
0020	23,6	8,50
0052	-	-
00CR	-	-
0009	-	-
0022	-	-
0023	-	-
0025	-	-
00CS	-	-
0026	-	-
0027	-	-
00FM	-	-
0035	-	-
0036	-	-
0038	-	-
0039	-	-
00AT	-	-
0028	17,4	1,70
0029	19,5	1,70
0030	-	-
0031	-	-

Cod.	cm	Euro
0001	19,6	1,95
0002	19,6	1,95
0003	21,0	3,30
00CC	-	-
00CA	-	-
00L3	-	-
0067	-	-
0004	17,8	1,70
0005	17,9	1,70
0006	19,2	3,10
00L6	-	-
00CD	-	-
00CB	-	-
0007	13,7	1,52
0008	12,3	1,06
0010	27,5	13,50
0011	22,0	5,50
0012	22,4	5,50
0013	18,0	7,50
0014	-	-
0015	-	-
0016	-	-
0059	-	-
00AW	-	-
0017	15,9	1,40
0018	-	-
00L9	-	-
0019	-	-
0020	21,7	8,50
0052	-	-
00CR	-	-
0009	-	-
0022	13,6	1,56
0023	-	-
0025	-	-
00CS	-	-
0026	-	-
0027	-	-
00FM	-	-
0035	-	-
0036	22,0	2,10
0038	-	-
0039	-	-
00AT	-	-
0028	19,8	2,25
0029	22,3	2,25
0030	-	-
0031	-	-

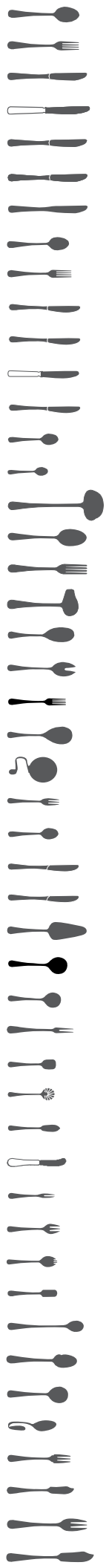

Beta

Cod. 1710

PINTINOX

inox 18/10
 master 120 pcs
 mm 2,5



Valencia

Cod. 0350

PINTINOX

inox 18/10
master 120 pcs
mm 2,0



Cod.	cm	Euro
0001	19,6	1,49
0002	19,6	1,49
0003	-	-
00CC	-	-
00CA	-	-
00L3	22,0	2,25
0067	-	-
0004	17,8	1,37
0005	17,7	1,37
0006	-	-
00L6	19,4	2,05
00CD	-	-
00CB	-	-
0007	14,1	1,03
0008	11,5	0,84
0010	26,9	13,50
0011	22,0	5,50
0012	21,9	5,50
0013	17,9	6,50
0014	-	-
0015	-	-
0016	-	-
0059	-	-
00AW	-	-
0017	15,1	1,03
0018	-	-
00L9	-	-
0019	-	-
0020	22,8	6,90
0052	-	-
00CR	-	-
0009	-	-
0022	-	-
0023	-	-
0025	-	-
00CS	-	-
0026	-	-
0027	-	-
00FM	-	-
0035	-	-
0036	-	-
0038	-	-
0039	-	-
00AT	-	-
0028	18,8	1,62
0029	19,6	1,62
0030	-	-
0031	-	-

Cod.	cm	Euro
0001	20,0	1,70
0002	20,0	1,70
0003	21,5	3,30
00CC	-	-
00CA	-	-
00L3	-	-
0067	-	-
0004	18,2	1,65
0005	18,0	1,65
0006	18,4	3,10
00L6	-	-
00CD	-	-
00CB	-	-
0007	14,3	1,07
0008	11,4	0,86
0010	28,0	13,50
0011	23,3	5,50
0012	23,3	5,50
0013	23,3	6,50
0014	-	-
0015	-	-
0016	-	-
0059	-	-
00AW	-	-
0017	14,7	1,35
0018	-	-
00L9	-	-
0019	-	-
0020	23,6	6,90
0052	-	-
00CR	-	-
0009	-	-
0022	-	-
0023	-	-
0025	-	-
00CS	-	-
0026	-	-
0027	-	-
00FM	-	-
0035	-	-
0036	-	-
0038	-	-
0039	-	-
00AT	-	-
0028	18,5	1,96
0029	20,0	1,96
0030	-	-
0031	-	-

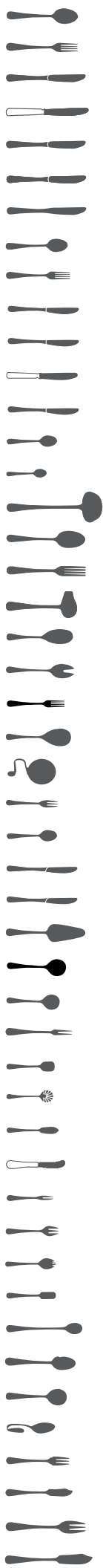

Novecento

Cod. 1320

PINTINOX

inox 18/10
master 120 pcs
mm 2,2



Superga

Cod. 0310

PINTINOX

inox 18/10
master 120 pcs
mm 2,0



Cod.	cm	Euro
0001	19,6	1,49
0002	19,6	1,49
0003	22,2	3,30
00CC	-	-
00CA	-	-
00L3	22,0	2,25
0067	-	-
0004	17,8	1,37
0005	17,7	1,37
0006	19,5	3,10
00L6	19,4	2,05
00CD	-	-
00CB	-	-
0007	14,1	1,03
0008	11,5	0,84
0010	26,9	13,50
0011	22,0	5,50
0012	21,9	5,50
0013	17,9	6,50
0014	-	-
0015	-	-
0016	-	-
0059	-	-
00AW	-	-
0017	15,1	1,03
0018	-	-
00L9	-	-
0019	-	-
0020	22,8	6,90
0052	-	-
00CR	-	-
0009	-	-
0022	-	-
0023	-	-
0025	-	-
00CS	-	-
0026	-	-
0027	-	-
00FM	-	-
0035	-	-
0036	-	-
0038	-	-
0039	-	-
00AT	-	-
0028	18,8	1,62
0029	19,6	1,62
0030	-	-
0031	-	-

Cod. cm Euro

0001	19,6	1,49
0002	19,6	1,49
0003	22,2	3,30
00CC	-	-
00CA	-	-
00L3	22,0	2,25
0067	22,9	3,50
0004	17,8	1,37
0005	17,7	1,37
0006	19,5	3,10
00L6	19,4	2,05
00CD	-	-
00CB	-	-
0007	14,1	1,03
0008	11,5	0,84
0010	26,9	13,50
0011	22,0	5,50
0012	21,9	5,50
0013	17,9	6,50
0014	-	-
0015	-	-
0016	-	-
0059	-	-
00AW	-	-
0017	15,1	1,03
0018	-	-
00L9	-	-
0019	-	-
0020	22,8	6,90
0052	-	-
00CR	-	-
0009	-	-
0022	-	-
0023	-	-
0025	-	-
00CS	-	-
0026	-	-
0027	-	-
00FM	-	-
0035	-	-
0036	21,0	1,58
0038	-	-
0039	-	-
00AT	-	-
0028	18,0	1,62
0029	19,6	1,62
0030	-	-
0031	-	-

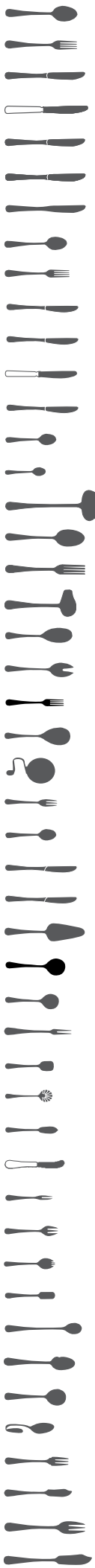

Stresa

Cod. 0320

PINTINOX

inox 18/10
master 120 pcs
mm 2,0



Cambridge

Cod. 071M

PINTINOX

inox 18/10
master 120 pcs
mm 2,0



Cod.	cm	Euro
0001	19,6	1,49
0002	19,6	1,49
0003	-	-
00CC	-	-
00CA	-	-
00L3	22,0	2,25
0067	22,9	3,50
0004	17,8	1,37
0005	17,7	1,37
0006	-	-
00L6	19,4	2,05
00CD	-	-
00CB	-	-
0007	14,1	1,03
0008	11,5	0,84
0010	26,9	13,50
0011	22,0	5,50
0012	21,9	5,50
0013	17,9	6,50
0014	-	-
0015	-	-
0016	-	-
0059	-	-
00AW	-	-
0017	15,1	1,03
0018	-	-
00L9	-	-
0019	-	-
0020	22,8	6,90
0052	-	-
00CR	-	-
0009	-	-
0022	-	-
0023	-	-
0025	-	-
00CS	-	-
0026	-	-
0027	-	-
00FM	-	-
0035	-	-
0036	-	-
0038	-	-
0039	-	-
00AT	-	-
0028	18,0	1,62
0029	19,6	1,62
0030	-	-
0031	-	-

Cod.	cm	Euro
0001	20,4	3,38
0002	20,4	3,38
0003	23,0	4,10
00CC	-	-
00CA	-	-
00L3	-	-
0067	-	-
0004	18,0	3,30
0005	18,0	3,30
0006	20,0	3,92
00L6	-	-
00CD	-	-
00CB	-	-
0007	13,7	2,66
0008	11,0	2,47
0010	-	-
0011	-	-
0012	-	-
0013	-	-
0014	-	-
0015	-	-
0016	-	-
0059	-	-
00AW	-	-
0017	-	-
0018	-	-
00L9	-	-
0019	-	-
0020	-	-
0052	-	-
00CR	-	-
0009	-	-
0022	-	-
0023	-	-
0025	-	-
00CS	-	-
0026	-	-
0027	-	-
00FM	-	-
0035	-	-
0036	-	-
0038	-	-
0039	-	-
00AT	-	-
0028	-	-
0029	-	-
0030	-	-
0031	-	-

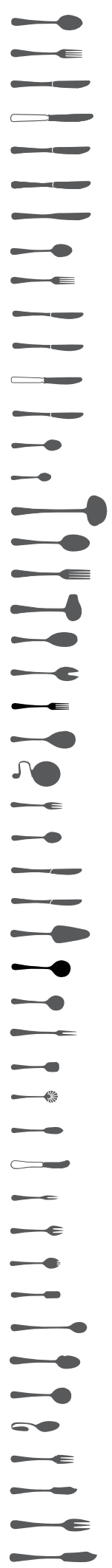

Trumpet

Cod. 2070

PINTINOX

inox 18% cromo/pulido
master 120 pcs
forjado



Tie

Cod. 2080

PINTINOX

inox 18% cromo/pulido
master 120 pcs
forjado



Cod.	cm	Euro
0001	20,0	3,23
0002	20,0	3,23
0003	22,0	3,80
00CC	-	-
00CA	-	-
00L3	-	-
0067	-	-
0004	18,0	3,08
0005	18,0	3,08
0006	20,0	3,65
00L6	-	-
00CD	-	-
00CB	-	-
0007	14,0	2,66
0008	11,0	2,36
0010	-	-
0011	-	-
0012	-	-
0013	-	-
0014	-	-
0015	-	-
0016	-	-
0059	-	-
00AW	-	-
0017	-	-
0018	-	-
00L9	-	-
0019	-	-
0020	-	-
0052	-	-
00CR	-	-
0009	-	-
0022	-	-
0023	-	-
0025	-	-
00CS	-	-
0026	-	-
0027	-	-
00FM	-	-
0035	-	-
0036	-	-
0038	-	-
0039	-	-
00AT	-	-
0028	-	-
0029	-	-
0030	-	-
0031	-	-

Cod.	cm	Euro
0001	21,0	1,90
0002	21,0	1,90
0003	22,6	2,70
00CC	-	-
00CA	-	-
00L3	-	-
0067	-	-
0004	-	-
0005	18,5	1,71
0006	20,3	2,55
00L6	-	-
00CD	-	-
00CB	-	-
0007	14,7	1,37
0008	11,0	0,76
0010	-	-
0011	-	-
0012	-	-
0013	-	-
0014	-	-
0015	-	-
0016	-	-
0059	-	-
00AW	-	-
0017	16,0	1,25
0018	-	-
00L9	-	-
0019	-	-
0020	-	-
0052	-	-
00CR	-	-
0009	-	-
0022	-	-
0023	-	-
0025	-	-
00CS	-	-
0026	-	-
0027	-	-
00FM	-	-
0035	-	-
0036	-	-
0038	-	-
0039	-	-
00AT	-	-
0028	-	-
0029	-	-
0030	-	-
0031	-	-

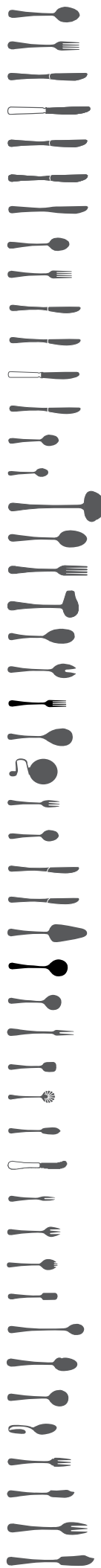

Wave

Cod. 2610

PINTINOX

inox 18% cromo/pulido
 master 120 pcs
 mm 3,0

Punto

Cod. 1220

PINTINOX

inox 18% cromo/spazzolato
master 120 pcs
mm 2,0



Cod.	cm	Euro
0001	19,7	1,35
0002	19,9	1,35
0003	-	-
00CC	-	-
00CA	-	-
00L3	21,6	2,20
0067	-	-
0004	-	-
0005	-	-
0006	-	-
00L6	19,5	1,95
00CD	-	-
00CB	-	-
0007	13,4	0,84
0008	11,4	0,70
0010	-	-
0011	-	-
0012	-	-
0013	-	-
0014	-	-
0015	-	-
0016	14,7	0,84
0059	-	-
00AW	-	-
0017	-	-
0018	-	-
00L9	-	-
0019	-	-
0020	-	-
0052	14,7	0,84
00CR	-	-
0009	-	-
0022	-	-
0023	-	-
0025	-	-
00CS	-	-
0026	-	-
0027	-	-
00FM	-	-
0035	-	-
0036	-	-
0038	-	-
0039	-	-
00AT	-	-
0028	-	-
0029	-	-
0030	-	-
0031	-	-

Cod.	cm	Euro
0001	21,0	1,16
0002	21,0	1,16
0003	-	-
00CC	-	-
00CA	-	-
00L3	22,0	2,25
0067	-	-
0004	-	-
0005	-	-
0006	-	-
00L6	-	-
00CD	-	-
00CB	-	-
0007	15,2	0,84
0008	11,1	0,80
0010	-	-
0011	-	-
0012	-	-
0013	-	-
0014	-	-
0015	-	-
0016	-	-
0059	-	-
00AW	-	-
0017	15,0	0,84
0018	-	-
00L9	-	-
0019	-	-
0020	-	-
0052	-	-
00CR	-	-
0009	-	-
0022	-	-
0023	-	-
0025	-	-
00CS	-	-
0026	-	-
0027	-	-
00FM	-	-
0035	-	-
0036	-	-
0038	-	-
0039	-	-
00AT	-	-
0028	-	-
0029	-	-
0030	-	-
0031	-	-

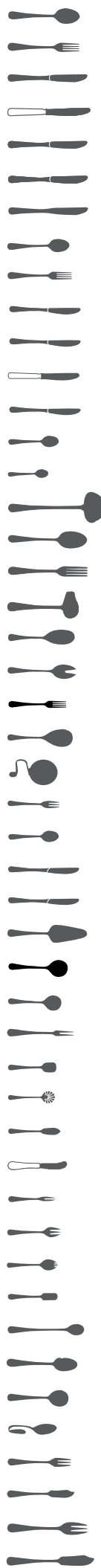

Touring

Cod. 1250

PINTINOX

inox 18% cromo/spazzolato
 master 120 pcs
 mm 2,0



Eco Baguette

Cod. 0280

PINTINOX

inox 18% cromo/spazzolato
master 120 pcs
mm 2,0



Cod.	cm	Euro
0001	19,6	1,22
0002	19,6	1,22
0003	-	-
00CC	-	-
00CA	-	-
00L3	22,0	2,90
0067	-	-
0004	17,8	1,18
0005	17,7	1,18
0006	-	-
00L6	19,5	2,80
00CD	-	-
00CB	-	-
0007	14,1	0,92
0008	15,5	0,76
0010	-	-
0011	-	-
0012	-	-
0013	-	-
0014	-	-
0015	-	-
0016	-	-
0059	-	-
00AW	-	-
0017	15,1	0,92
0018	-	-
00L9	-	-
0019	-	-
0020	-	-
0052	-	-
00CR	-	-
0009	-	-
0022	-	-
0023	-	-
0025	-	-
00CS	-	-
0026	-	-
0027	-	-
00FM	-	-
0035	-	-
0036	-	-
0038	-	-
0039	-	-
00AT	-	-
0028	18,0	1,15
0029	19,6	1,15
0030	-	-
0031	-	-

Stone Washed

	SPATEN 163200..	VITTORIALE 164200..	BAGUETTE 083200..	SETTECENTO 205400..	PALACE 169200..	CASALI 210200..
01	€ 5,00	€ 5,00	€ 4,48	€ 3,86	€ 3,54	€ 3,54
02	€ 5,00	€ 5,00	€ 4,48	€ 3,86	€ 3,54	€ 3,54
03	€ 7,46	€ 7,46	€ 6,92	€ 6,26	€ 5,94	€ 5,62
L3	-	-	-	-	-	-
04	€ 4,90	€ 4,90	€ 4,38	€ 3,74	€ 3,54	€ 3,54
05	€ 4,90	€ 4,90	€ 4,38	€ 3,74	€ 3,54	€ 3,54
06	€ 7,34	€ 7,34	€ 6,80	€ 6,16	€ 5,94	€ 5,62
07	€ 2,70	€ 2,70	€ 2,60	€ 2,40	€ 2,40	€ 2,18
08	€ 2,70	€ 2,70	€ 2,60	€ 2,40	€ 2,40	€ 2,18
10	€ 17,00	€ 17,00	€ 17,00	€ 16,90	€ 18,36	€ 16,18
11	€ 8,60	€ 8,60	€ 7,84	€ 7,50	€ 8,80	€ 7,44
12	€ 8,60	€ 8,60	€ 7,84	€ 7,50	€ 8,80	€ 7,44
17	€ 3,44	€ 3,44	€ 3,44	€ 2,60	€ 2,60	€ 2,60
20	€ 11,36	€ 11,36	€ 11,36	€ 10,80	€ 10,80	€ 10,80
67	-	-	€ 6,92	-	€ 5,94	-
28	€ 4,90	€ 4,90	€ 4,38	€ 3,86	€ 3,54	-
29	€ 4,90	€ 4,90	€ 4,38	€ 3,86	€ 3,54	-



Alchimique Titanium

	SETTECENTO 0JC400..	CASALI 0YC200..	PALACE 0ZC200..	VITTORIALE 0VB200.. <i>on demand</i>	BAGUETTE 0WC200.. <i>on demand</i>
01	€ 12,38	€ 12,06	€ 12,06	€ 13,52	€ 13,00
02	€ 12,38	€ 12,06	€ 12,06	€ 13,52	€ 13,00
03	€ 15,12	€ 15,12	€ 18,95	€ 18,50	€ 17,80
04	€ 12,38	€ 12,06	€ 12,06	€ 13,42	€ 12,90
05	€ 12,38	€ 12,06	€ 12,06	€ 13,42	€ 12,90
06	€ 15,00	€ 15,00	€ 18,00	€ 17,95	€ 17,50
07	€ 8,12	€ 8,02	€ 8,12	€ 8,54	€ 8,42
08	€ 8,12	€ 8,02	€ 8,12	€ 8,54	€ 8,42
10	€ 47,50	€ 47,50	€ 47,50	€ 47,50	€ 47,50
11	€ 20,50	€ 20,50	€ 23,70	€ 21,75	€ 21,75
12	€ 20,50	€ 20,50	€ 23,70	€ 21,75	€ 21,75
17	€ 8,42	€ 8,42	€ 8,55	€ 9,26	€ 9,26
20	€ 27,96	€ 27,88	€ 35,90	€ 32,15	€ 32,15
39	€ 12,38	€ 11,96	€ 12,06	€ 13,42	€ 12,80
67	-	-	€ 18,95	-	€ 17,80
28	€ 12,38	€ 12,06	€ 12,06	€ 13,52	€ 13,00
29	€ 12,38	€ 12,06	€ 12,06	€ 13,52	€ 13,00



Alchimique Bronze

	SETTECENTO OJB400..	CASALI OYB200..	BAGUETTE OWB200..	VITTORIALE OVB200.. <i>on demand</i>	PALACE OZB200.. <i>on demand</i>
01	€ 12,38	€ 12,06	€ 13,00	€ 13,52	€ 12,06
02	€ 12,38	€ 12,06	€ 13,00	€ 13,52	€ 12,06
03	€ 15,12	€ 15,12	€ 17,80	€ 18,50	€ 18,95
04	€ 12,38	€ 12,06	€ 12,90	€ 13,42	€ 12,06
05	€ 12,38	€ 12,06	€ 12,90	€ 13,42	€ 12,06
06	€ 15,00	€ 15,00	€ 17,50	€ 17,95	€ 18,00
07	€ 8,12	€ 8,02	€ 8,42	€ 8,54	€ 8,12
08	€ 8,12	€ 8,02	€ 8,42	€ 8,54	€ 8,12
10	€ 47,50	€ 47,50	€ 47,50	€ 47,50	€ 47,50
11	€ 20,50	€ 20,50	€ 21,75	€ 21,75	€ 23,70
12	€ 20,50	€ 20,50	€ 21,75	€ 21,75	€ 23,70
17	€ 8,42	€ 8,42	€ 9,26	€ 9,26	€ 8,55
20	€ 27,96	€ 27,88	€ 32,15	€ 32,15	€ 35,90
67	-	-	€ 17,80	-	€ 18,95
28	€ 12,38	€ 12,06	€ 13,00	€ 13,52	€ 12,06
29	€ 12,38	€ 12,06	€ 13,00	€ 13,52	€ 12,06



Alchimique Gold

	SETTECENTO OJA400..	CASALI OYA200..	VITTORIALE OVA200..	BAGUETTE OWA200.. <i>on demand</i>	PALACE OZA200.. <i>on demand</i>
01	€ 9,16	€ 8,84	€ 10,30	€ 9,78	€ 8,84
02	€ 9,16	€ 8,84	€ 10,30	€ 9,78	€ 8,84
03	€ 13,90	€ 13,50	€ 14,50	€ 13,90	€ 13,90
04	€ 9,06	€ 8,84	€ 10,20	€ 9,68	€ 8,84
05	€ 9,06	€ 8,84	€ 10,20	€ 9,68	€ 8,84
06	€ 13,80	€ 13,20	€ 14,30	€ 13,80	€ 13,80
07	€ 6,76	€ 6,66	€ 7,18	€ 7,08	€ 6,88
08	€ 6,76	€ 6,66	€ 7,18	€ 7,08	€ 6,88
10	€ 44,50	€ 44,50	€ 44,50	€ 44,50	€ 44,50
11	€ 17,60	€ 17,60	€ 18,60	€ 17,60	€ 17,60
12	€ 17,60	€ 17,60	€ 18,60	€ 17,60	€ 17,60
17	€ 7,65	€ 7,08	€ 7,90	€ 7,90	€ 7,90
20	€ 26,40	€ 26,40	€ 28,90	€ 28,90	€ 26,40
67	-	-	-	€ 12,42	€ 11,46
28	€ 9,16	€ 8,84	€ 10,30	€ 9,78	€ 8,84
29	€ 9,16	€ 8,84	€ 10,30	€ 9,78	€ 8,84



Treasure Gold

	SETTECENTO 08A000..	BAGUETTE 06A000..	SYNTHESIS 15A000..	OLIVIA 14A000..
01	€ 8,42	€ 8,94	€ 8,02	€ 9,16
02	€ 8,42	€ 8,94	€ 8,02	€ 9,16
03	€ 10,82	€ 11,46	€ 10,48	€ 11,78
04	€ 8,32	€ 8,94	€ 8,02	€ 9,16
05	€ 8,32	€ 8,94	€ 8,02	€ 9,16
06	€ 10,72	€ 11,26	€ 10,48	€ 11,78
07	€ 6,08	€ 6,38	€ 6,04	€ 6,66
08	€ 5,58	€ 5,78	€ 5,54	€ 6,16
17	€ 7,18	€ 8,02	€ 7,18	€ 8,22



Treasure Bronze

	SETTECENTO 08B000..	BAGUETTE 06B000..	SYNTHESIS 15B000..	OLIVIA 14B000..
01	€ 11,52	€ 12,04	€ 11,24	€ 12,38
02	€ 11,52	€ 12,04	€ 11,24	€ 12,38
03	€ 13,92	€ 14,56	€ 13,82	€ 15,12
04	€ 11,42	€ 12,04	€ 11,24	€ 12,38
05	€ 11,42	€ 12,04	€ 11,24	€ 12,38
06	€ 13,82	€ 14,36	€ 13,82	€ 15,12
07	€ 7,48	€ 7,78	€ 7,50	€ 8,12
08	€ 7,48	€ 7,68	€ 7,50	€ 8,12
17	€ 10,28	€ 11,12	€ 10,40	€ 11,44



Treasure Titanium

	SETTECENTO 08C000..	BAGUETTE 06C000..	SYNTHESIS 15C000..	OLIVIA 14C000..
01	€ 11,52	€ 12,04	€ 11,24	€ 12,38
02	€ 11,52	€ 12,04	€ 11,24	€ 12,38
03	€ 13,92	€ 14,56	€ 13,82	€ 15,12
04	€ 11,42	€ 12,04	€ 11,24	€ 12,38
05	€ 11,42	€ 12,04	€ 11,24	€ 12,38
06	€ 13,82	€ 14,36	€ 13,82	€ 15,12
07	€ 7,48	€ 7,78	€ 7,50	€ 8,12
08	€ 7,48	€ 7,68	€ 7,50	€ 8,12
17	€ 10,28	€ 11,12	€ 10,40	€ 11,44





Confezioni (posate)

Box (cutlery)

Boite (couverts)

Geschenckpackung (bestecke)

Confección (cubiertos)

Estuches cubiertos

PINTI1929®

MODELO	CODIGO	CARTON 4pz. Euro	MADERA 24pz. Euro	CARTON 75pz. Euro	MADERA 113pz. Euro
<i>Bramante</i>	0780	32,00	186,00	-	840,00
<i>Ellade</i>	0790	32,00	202,00	-	920,00
<i>Privilege</i>	0510	23,50	117,00	-	512,00
<i>Concept</i>	0450	23,50	112,00	-	501,00
<i>Tecna</i>	0470	23,00	107,00	-	480,00
<i>Olivia</i>	0490	22,50	102,00	-	475,00
<i>Spaten</i>	1630	26,00	121,00	-	550,00
<i>Vittoriale</i>	1640	26,00	121,00	-	550,00
<i>Swing</i>	0880	24,00	103,00	316,00	463,00
<i>Baguette</i>	0830	23,00	107,00	329,00	478,00
<i>Byron</i>	0800	23,00	107,00	329,00	478,00
<i>Palladium</i>	0590	23,00	107,00	329,00	478,00
<i>Pitagora</i>	0810	23,00	107,00	329,00	478,00
<i>Leonardo</i>	0500	23,00	107,00	329,00	478,00

Estuches cubiertos

PINTINOX

MODELO	CODIGO	CARTON			
		4pz. Euro	24pz. Euro	75pz. Euro	113pz. Euro
<i>Millenium</i>	2270	22,00	95,00	328,00	426,00
<i>Ritz</i>	2280	22,00	95,00	328,00	426,00
<i>Romanino</i>	0650	22,00	97,00	314,00	418,00
<i>Settecento</i>	2050	21,00	83,00	257,00	370,00
<i>Carlton</i>	1780	-	79,00	257,00	-
<i>Palace</i>	1690	20,00	80,00	257,00	360,00
<i>Savoy</i>	1700	20,00	80,00	257,00	360,00
<i>Liberty</i>	1660	22,00	93,00	304,00	419,00
<i>Casali</i>	2100	19,50	77,00	236,00	341,00
<i>Trend</i>	1670	21,00	84,00	274,00	370,00
<i>Synthesis</i>	2030	19,50	73,00	235,00	335,00
<i>Solaris</i>	2170	19,50	75,00	238,00	333,00
<i>Sirio</i>	2260	20,00	76,00	244,00	338,00
<i>Roma</i>	2200	20,00	76,00	244,00	338,00
<i>Sabrina</i>	2090	20,00	78,00	248,00	347,00

Estuches cubiertos

PINTINOX

MODELO	CODIGO	CARTON			
		4pz. Euro	24pz. Euro	75pz. Euro	113pz. Euro
<i>Maitre</i>	2010	20,00	72,00	235,00	339,00
<i>Bristol</i>	2140	18,50	69,00	222,00	320,00
<i>Hotel</i>	2020	18,00	65,00	212,00	302,00
<i>America</i>	2240	18,00	64,00	208,00	300,00
<i>Beta</i>	1710	18,00	64,00	206,00	298,00
<i>Gamma</i>	2150	18,00	64,00	206,00	298,00
<i>Ischia</i>	2250	18,00	64,00	202,00	289,00
<i>Tema</i>	2120	17,00	61,00	193,00	270,00
<i>Novecento</i>	1320	17,00	59,00	203,00	272,00
<i>Superga</i>	0310	17,00	56,00	183,00	255,00
<i>Stresa</i>	0320	17,00	56,00	183,00	255,00
<i>Valencia</i>	0350	16,00	50,00	158,00	229,00
<i>Cambridge</i>	071M	16,00	50,00	158,00	229,00
<i>Tie</i>	2080	22,00	90,00	-	-
<i>Trumpet</i>	2070	22,00	90,00	-	-

Confezioni regalo vuote

Cajas regalo vacias para juegos de cubertería



ESTUCHE 4 PZ

material	pz	Euro
carton	4	11,50



ESTUCHE 24 PZ

material	pz	Euro
madera	24	23,50
carton	24	15,00



ESTUCHE 75 PZ

material	pz	Euro
carton	75	27,50

75/113 pz



















ESTUCHE 113 PZ

material	pz	Euro
madera	113	77,00
carton	113	40,00

113 pz

Composizioni standard servizi posate

Composición para cuberterías en estuches

		6	12	
		Persone Persons	Persone Persons	
Descrizione Description				
POSATE TAVOLA - TABLE ITEMS - COUVERTS TABLE - TAFELBESTECKE - CUBIERTOS MESA				
	01 Cucchiaino - Spoon - Cuiller - Löffel - Cuchara	6	12	12
	02 Forchetta - Fork - Fourchette - Gabel - Tenedor	6	12	12
	03 Coltello - Knife - Couteau - Messer - Cuchillo	6	12	12
POSATE FRUTTA - DESSERT ITEMS - COUVERTS DESSERT - DESSERTBESTECKE - CUBIERTOS POSTRE				
	04 Cucchiaino - Spoon - Cuiller - Löffel - Cuchara	-	-	-
	05 Forchetta - Fork - Fourchette - Gabel - Tenedor	-	12	12
	06 Coltello - Knife - Couteau - Messer - Cuchillo	-	12	12
CAFFÈ - TEA/COFFEE SPOON - CAFÉ - KAFFEE - CAFÉ				
	07 Cucchiaino caffè - Tea-coffee spoon - Cuiller à café - Kaffeelöffel - Cuchara café	6	12	12
	08 Cucchiaino moka - Moka spoon Cuiller à moka - Mokkalöffel - Cuchara moka	-	-	12
SERVIRE - SERVING - SERVICE - SERVIER - SERVIR				
	10 Mestolo - Soup ladle - Louche - Suppenschöpfer Cazo sopa	-	1	1
	11 Cucchiaino - Serving spoon - Cuiller de service Gemüselöffel - Cuchara servir	-	1	1
	12 Forchettone - Serving fork - Fourchette de service Serviergabel Tenedor servir	-	1	1
	13 Mestolo salsa - Sauce ladle - Louche à sauce Saucenlöffel - Cacillo salsa	-	-	1
	15* Forchetta insalata - Salad fork - Fourchette à salade Salatgabel - Tenedor ensalada	-	-	-
	17 Forchettina 3 spine - Pastry fork - Fourchette à gateau - Kuchengabel 3 Zinken - Tenedor postre 3 púas	-	-	-
	20 Pala torta - Cake server - Pelle à tarte - Tortenheber - Pala pastel	-	-	1
	28 Forchetta pesce - Fish fork - Fourchette à poisson - Fischgabel - Tenedor pescado	-	-	12
	29 Coltello pesce - Fish knife - Couteau à poisson - Fischmesser - Cuchillo pescado	-	-	12
TOTALE PEZZI - PCS		24	75	113

Il codice 15* dove non disponibile verrà sostituito con il cucchiaino servire codice 11 • Code 15*, if not available, will be replaced by serving spoon code 11 • La réf. 15*, si elle n'est pas disponible, sera remplacée par la cuillère à servir code 11 • Wenn nicht lieferbar, kann die Artikelnummer 15* von Artikelnummer eingesetzt werden • Código número 15*, si no está disponible, puede ser remplazado por el código número 11

inox
18/10

Baby

Cod. 105000B6

PINTINOX
acciaio inox/stainless steel

Euro 19,00

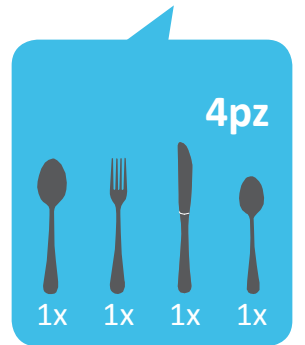

Sushi King

Cod. 24_07091

PINTI1929®

acciaio inox- ASA / stainless steel-ASA
5 set per Master

Euro 94,00

inox

24pz

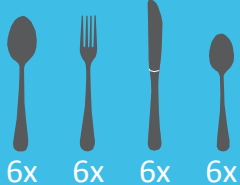

24C0709 Teak/Teak



24D0709 Wenge/Wenge



24E0709 Ebano/Ebony



24B0709 Mogano/Mahogany



24A0709 Betulla/Birch



Sushi Queen

Cod. 17_07091

PINTI1929[®]

acciaio inox- ASA / stainless steel-ASA
5 set per Master

Euro 92,00



17C0709 Teak/Teak



17D0709 Wenge/Wenge



17E0709 Ebano/Ebony



17B0709 Mogano /Mahogany



17A0709 Betulla/Birch



Movie

Cod. 02_07091

PINTI1929®

acciaio inox- ASA / stainless steel-ASA
5 set per Master

Euro 45,00

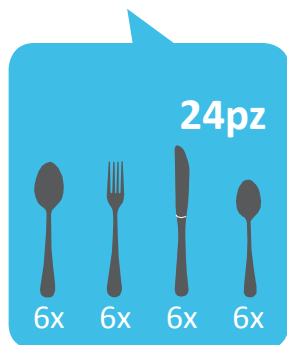

02F07091 Blu/Blue



02D07091 Viola/Purple



02E07091 Rosso/Red



02C0709 Verde/Green



02B07091 Arancione/Orange



02A07091 Nero/Black



Freccia

Cod. 11_07091

PINTI1929[®]

acciaio inox 2mm - ASA
stainless steel 2mm - ASA

5 set per Master

Euro 31,50

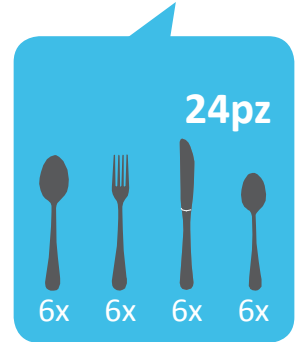

design
Daniele Ardisson



11B07091 Bianco/White



11G07091 Verde menta/Mint green



11F07091 Lilla/Lilac



11A07091 Rosso/Red



11E07091 Blu acqua/Water blue



11D07091 Pesca/Peach



11C07091 Nero/Black



Gli Speciali

Esclusivi
Speciali
Professional
Astra



1:1

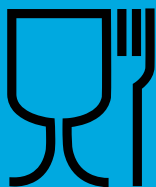

Per alimenti
Suitable for foodstuffs
Apte au contact avec les aliments
Für Lebensmittel
Apto para alimentos

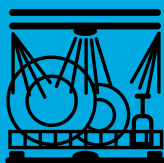

Garantito per lavastoviglie
Dishwasher safe
Inalterable dans lave-vaisselle
Spelmaschinenfest
Apto para lavavajillas

inox

Forged

Esclusivi tavola

CUCCHIAIO TAVOLA 18/10

Table spoon 18/10 - Cuiller de table 18/10
Tafellöffel 18/10 - Cuchara de mesa 18/10

Cod. 07400001



cm Euro

20 6,45

FORCHETTA TAVOLA 18/10

Table fork 18/10 - Fourchette de table 18/10
Gabel mit 18/10 - Tenedor de mesa 18/10

Cod. 07400002



cm Euro

19,5 6,45

COLTELLO BISTECCA

Steak knife - Couteau steak
Steakmesser - Cuchillo chuletero

Cod. 07400067



cm Euro

21,1 6,45

CUCCHIAINO CAFFÈ 18/10

Tea-coffee spoon 18/10 - Cuiller a cafe 18/10
Kaffeelöffel 18/10 - Cuchara café 18/10

Cod. 07400007



cm Euro

14,6 3,30

pasta

PALA LASAGNE 18/10

Lasagne server 18/10 - Pelle a lasagnes 18/10
Lasagneheber 18/10 - Paleta lasañas 18/10

Cod. 074000AE



cm Euro

28 22,50

SERVISPAGHETTI 18/10

Spaghetti server 18/10 - Cuiller spaghetti 18/10

Spaghettischöpfer 18/10 - Cuchara de servir para espaguetis 18/10

Cod. 074000AS

cm	Euro
----	------

29,5	24,50
------	-------



carne

FORCHETTONE ARROSTO 18/10

Carving fork 18/10 - Fourchette a roti 18/10

Vorlegegabel tenedor 18/10 - Trinchante asado 18/10

Cod. 07400068

cm	Euro
----	------

25,7	20,50
------	-------



COLTELLONE ARROSTO cm 28

Carving knife - Couteau a roti

Vorlegemesser - Cuchillo grande asado

Cod. 07400069

cm	Euro
----	------

28	20,50
----	-------



TRINCIAPOLLO

Poultry shears - Coupe-volailles

Geflügelschere - Tijeras para aves

Cod. 074000AN

cm	Euro
----	------

25	47,00
----	-------



inox

Forged

Esclusivi

pesce

SCAVINO PER ARAGOSTA 18/10

Lobster pick 18/10 - Curette a homard 18/10
Langustengabel 18/10 - Utensilio para langosta 18/10

Cod. 074000AF



cm	Euro
----	------

18,8	8,20
------	------

PINZA PER ARAGOSTA 18/10

Lobster/seafood cracker - Pince a crustaces
Langustenzange - Pinza para langosta

Cod. 074000AG



cm	Euro
----	------

18,8	26,50
------	-------

formaggi

COLTELLO FORMAGGIO 2 PUNTE

Cheese knife - Couteau a fromage
Käsemesser 2 zinken - Cuchillo queso 2 puntas

Cod. 074000AA



cm	Euro
----	------

21,8	9,85
------	------

COLTELLO GRANA

Parmesan pick - Couteau a parmesan
Parmesankäsemesser - Cuchillo queso duro

Cod. 074000AB



cm	Euro
----	------

18,2	9,60
------	------

COLTELLO FORMAGGIO DURO

Parmesan knife - Couteau fromage

Käsemesser - Cuchillo queso

Cod. 074000AD

cm Euro

25,9 11,50



COLTELLO FORMAGGIO TENERO

Soft cheese knife - Couteau fromage pate molle

Messer für Weichkäse - Cuchillo queso blando

Cod. 074000AL

cm Euro

21,5 7,35



pizza

COLTELLO PIZZA/CROSTACEI

Pizza / seafood knife - Couteau a pizza/crustaces

Pizza/krustentiere messer - Cuchillo pizza/marisco

Cod. 07400051

cm Euro

21 5,20



COLTELLO TAGLIO PIZZA

Pizza serving knife - Couteau a pizza

Serviermesser für pizza - Cuchillo corte pizza

Cod. 074000AD

cm Euro

21,5 11,50



PALA SERVIRE PIZZA 18/10

Pizza server 18/10 - Pelle de service pour pizza 18/10

Pizzaschieber 18/10 - Paleta servir pizza 18/10

Cod. 074000AI

cm Euro

21,5 26,20



inox

Forged

Esclusivi taverna

SCHIACCIANOCI

*Nutcraker - Casse-noix
Nussknacker - Cascanueces*

Cod. 074000AH

cm Euro

18,7 27,00



COLTELLO AGRUMI

*Lemon/bar knife - Couteau agrumes
Südfruchtmesser - Cuchillo citricos*

Cod. 074000AM

cm Euro

23 7,50



CAVATAPPI A CAMPANA

*Cork screw - Tirebouchon
Korkenzieher - Sacacorchos a campana*

Cod. 074000AR

cm Euro

25,9 58,00



Esclusivi

Forged

inox

dolce e pane

PALA DOLCE 18/10

*Cake server 18/10 - Pelle a tarte 18/10
Tortenheber 18/10 - Paleta postre 18/10*

Cod. 074000AP

cm	Euro
----	------

27,8	21,50
------	-------



COLTELLO PANE

*Bread knife - Couteau a pain
Brotmesser - Cuchillo pan*

Cod. 074000AC

cm	Euro
----	------

31,8	15,50
------	-------



Ogni pezzo è confezionato singolarmente.
Packaging in individual gift bag.
En sachet cadeau individuel.
In Geschenkbeutel.
Cada artículo está presentado en bolsa de regalo.

inox

Forged

Speciali

0067 coltello bisecca *meat knife* cuchillo para carne



	Cod.	cm	Euro
<i>Professionale</i>	07600067	23	5,90



	Cod.	cm	Euro
<i>Byron 1929</i>	08000067	23	5,90



	Cod.	cm	Euro
<i>Baguette 1929</i>	08300067	23	5,90



	Cod.	cm	Euro
<i>Ritz</i>	22800067	22,8	4,50



	Cod.	cm	Euro
<i>Millenium</i>	22700067	23,6	4,50



	Cod.	cm	Euro
<i>Sabrina</i>	20900067	22,5	4,45



Cod.	cm	Euro
16900067	22	3,95

Palace



Cod.	cm	Euro
05000067	23	5,90

Leonardo



Cod.	cm	Euro
20300067	22,5	3,80

Synthesis



Cod.	cm	Euro
03200067	22,9	3,50

Stresa



Cod.	cm	Euro
076000EU	22,3	7,50

Profess. C/m in plastica



*pizza Stressa*

Cod.	cm	Euro
03200051	21,3	3,50

*bistecca Cateri*

Cod.	cm	Euro
07500067	23	3,50

*pizza Cateri*

Cod.	cm	Euro
07500051	21	3,50

**FORCHETTA PIZZA CATERÌ 18/10***Pizza fork 18/10 - Fourchette à pizza 18/10**Pizza Gabel 18/10 - Tenedor pizza 18/10***Cod. 07500066**

cm	Euro
19,51	1,60

**CUCCHIAIO LUNGO 18/10***Long spoon 18/10 - Cuiller long 18/10**Spaghettilöffel 18/10 - Cuchara largo 18/10***Cod. 07500057**

cm	Euro
22	2,85

FORCHETTA LUNGA 18/10

Long fork 18/10 - Fourchette longue 18/10
Spaghettigabel 18/10 - Tenedor largo 18/10

Cod. 07500058

cm Euro

22 2,85



SCAVINO CROSTACEI

Lobster pick - Fourchette pour crustacés
Krustentiergabel - Utensilio para crustáceos

Cod. 076000AF

cm Euro

18,5 2,00



PINZA ARAGOSTA PROFESSIONAL CON MOLLA

Lobster cracker - Pince pour crustacés
Langustenzange - Pinza para langosta

Cod. 741000AG

cm Euro

18,7 16,50



MULTIUSO CROSTACEI I PROFESSIONALI

Sea food pick - Fourchette pour crustacés
Krustentiergabel - Utensilio para crustáceos

Cod. 076000MU

cm Euro

23 2,95



inoxSOLO VENDITA MASTER
ONLY MASTER SELLING

Coltelli professional

Knife Couteau Messer Cuchillo



MANARETTA

Cleaver - Couperet
Kochmesser - Cuchillo de carnicero
Cod. 741000EG

lama cm	Euro	master
18	23,30	4



COLTELLO MACELLAIO LAMA GRANDE

Butcher's knife - Boucher
Fleischmesser - Cuchillo carnicero

Cod.	lama cm	Euro	master
741000E6	20	16.30	6
741000E7	25	19,85	6



COLTELLO CUCINA

Chef knife - Couteau de cuisine
Küchenmesser - Cuchillo de cocina

Cod.	lama cm	Euro	master
741000EH	20	15,75	6
741000E1	25	18,10	6



COLTELLO CUCINA ORIENTALE

Japanese cook - Couteau de cuisine
Küchenmesser - Cuchillo de cocina
Cod. 741000EI

lama cm	Euro	master
18	14,95	6

I coltelli professionali vengono distribuiti in una custodia salva-lama con appendino.
Master da 6 coltelli. Ordini minimi 6 pezzi. Vendita multipli da 6 pezzi
Professionale knives are packed in a hanging protective slive. Master 6 pieces. Minimum order 6 pieces.
The selling unit is 6 pieces and multiples.

Coltelli professional

SOLO VENDITA MASTER
ONLY MASTER SELLING

inox

COLTELLO CUCINA

Chef knife - Couteau de cuisine
Küchenmesser - Cuchillo de cocina

Cod. 741000EL

lama cm	Euro	master
15	14,80	6



COLTELLO PANE

Bread knife - Couteau à pain
Brotmesser - Cuchillo de pan

Cod.	lama cm	Euro	master
741000EM	20	13,15	6
741000E5	28	17,60	6



COLTELLO AFFETTATI

Slicer knife - Couteau à charcuterie
Ausschnittmesser - Cuchillo para fiambre

Cod. 741000EN

lama cm	Euro	master
20	13,75	6



COLTELLO DISOSSATORE

Boning knife - Couteau désosseur
Ausbeinmesser - Cuchillo deshuesador

Cod. 741000EO

lama cm	Euro	master
15	13,75	6



COLTELLO PER FILETTARE

Fillet knife - Couteau à fileter
Filetierreisser - Cuchillo rebanador

Cod. 741000EP

lama cm	Euro	master
20	13,75	6



inox

SOLO VENDITA MASTER
ONLY MASTER SELLING

Coltelli professional

COLTELLO PROSCIUTTO

*Ham-Slicer - Couteau à jambon
Schinkenmesser - Cuchillo jamón*

Cod.	lama cm	Euro	master
741000EQ	26	14,90	6
741000E4	33	15,80	6



COLTELLO SALMONE

*Salmon knife - Couteau à saumon
Lachsmesser - Cuchillo para salmón*

Cod. 741000ER

lama cm	Euro	master
26	15,60	6



FORCHETTONE ARROSTO

*Carving fork - Fourchette à rôti
Bratengabel - Tenedor para asado*

Cod. 741000ES

lama cm	Euro	master
18	12,90	6



COLTELLO CUCINA

*Chef knife - Couteau de cuisine
Küchenmesser - Cuchillo de cocina*

Cod. 741000ET

lama cm	Euro	master
12	8,85	6



COLTELLO BISTECCA CON SEGA

Full serration steak knife - Couteau à viande avec scie
Steakmesser mit Sägeschliff - Cuchillo de carne con dientes

Cod. 741000EU

lama cm	Euro	master
12	9,30	6



COLTELLO BISTECCA SENZA SEGA

Fine edged steak knife - Couteau à viande sans scie
Steakmesser ohne Sägeschliff - Cuchillo de carne sin dientes

Cod. 741000EY

lama cm	Euro	master
12	8,90	6



COLTELLO SPELUCCHINO

Paring knife - Couteau éplucheur
Spickmesser - Cuchillo pelador

Cod.	lama cm	Euro	master
741000EV	9	8,50	6
741000E2	10	8,70	6



COLTELLO VERDURA

Peeling knife - Couteau à légumes
Gemüsemesser - Cuchillo para verdura

Cod. 741000EZ

lama cm	Euro	master
7,5	8,50	6



inox

SOLO VENDITA MASTER
ONLY MASTER SELLING

Coltelli professional



MEZZALUNA

Mincing knife - Berceuse
Gemüsemesser - Media luna

Cod. 741000EB

lama cm	Euro	master
26	23,25	4

PUNTA GRANA

Parmesan cheese knife - Couteau à Parmesan
Parmesankäsemesser - Cuchillo queso duro

Cod. 741000EX



lama cm	Euro	master
12	12,50	6

APPENDINO MAGNETICO

Aluminium magnet hanger - Crochet magnétique
Magnethalter - Colgador magnético

Cod. 741000ED



lama cm	Euro	master
45	19,50	6

ACCIAINO

Sharpener - Fusil aiguiser
Messerschaerfer - Afilador

Cod. 741000E3



lama cm	Euro	master
24,5	15,50	6



Ogni pezzo è confezionato singolarmente.

Packaging in individual gift bag.

En sachet cadeau individuel
In Geschenkbeutel.

Cada artículo está presentado en bolsa de regalo.

CEPPO LEGNO 6 PEZZI CUCINA

6 kitchen knives with wood block - 6 couteaux cuisine avec bloc en bois
Messerblock 6-tlg Küchenmesser - Bloque madera 6pz. cuchillo cocina

Cod. 741000EE

Euro 107,00

Composto da 6 pezzi
Consisting of 6 pcs - Composé de
6 pièces - Besteht aus 6 Teilen -
Compuesto de 6 piezas:

> **Coltello Cucina cm 20**

Chef knife cm 20 - Couteau de
cuisine cm 20 - Küchenmesser cm
20 - Cuchillo de cocina cm 20

> **Coltello Pane cm 20**

Bread knife cm 20 - Couteau à
pain cm 20 - Brotmesser cm 20 -
Cuchillo de pan cm 20

> **Coltello Affettati cm 20**

Slicer knife cm 20 - Couteau
à charcuterie cm 20 -
Ausschnittmesser cm 20 - Cuchillo
para fiambre cm 20

> **Coltello cucina cm 12**

Chef knife cm 12 - Couteau de
cuisine cm 12 - Küchenmesser cm
12 - Cuchillo de cocina cm 12

> **Spelucchino cm 9**

Paring knife cm 9 - Couteau
éplucheur cm 9 - Spickmesser cm
9 - Cuchillo pelador cm 9

> **Coltello verdura cm 7,5**

Peeling knife cm 7,5 - Couteau à
légumes cm 7,5 - Gemüsemesser
cm 7,5 - Cuchillo para verdura cm
7,5



In scatola regalo.

Packaging in gift
box.

En boîte cadeau.

Geschenckpackung.

En caja de regalo.



**FORCHETA 5 PUNTE**

5 prong fork - Fourchette à 5 dents
Serviergabel 5 zinken - Tenedor 5 púas

Cod. 07600143

cm	(Euro pcs)	master
30	9,65	12

**CUCCHIAIONE RISOTTO**

Rice spoon - Cuiller à "risotto"
Reislöffel - Cuchara de arroz

Cod. 07600280

cm	(Euro pcs)	master
28	10,50	12

**CUCCHIAIONE RISOTTO FORATO**

Perforated rice spoon - Cuiller perforé à "risotto"
Reislöffel gelocht - Cuchara de arroz con agujeros

Cod. 07600260

cm	(Euro pcs)	master
26	8,95	12

**COLTELLO SERVIRE**

Serving knife - Couteau à servir
Serviermesser - Cuchillo servir

Cod. 07600069

cm	(Euro pcs)	master
32	13,80	12

CUCCHIAIONE SERVIRE

Serving spoon - Cuiller à servir
Servierlöffel - Cuchara servir

Cod. 07600060

cm	(Euro pcs)	master
26	8,95	12

**PALA LASAGNE**

Spatula lasagna - Pelle à lasagnes
Lasagneheber - Pala lasaña

Cod. 07600080

cm	(Euro pcs)	master
28	11,45	12

**PALA TORTA**

Cake server - Pelle à torte
Tortenheber - Pala pastel

Cod. 07600081

cm	(Euro pcs)	master
30	13,75	12

**PALA UOVO**

Egg lifter - Pelle à oeuf
Eierheber - Pala huevos

Cod. 07600082

cm	(Euro pcs)	master
28	15,15	12





CUCCHIAIONE PIZZAIOLO

Tomato spoon - Cuiller à tomates

Pizza Löffel - Cuchara para pizza

Cod. 07600014

cm	(Euro pcs)	master
28	8,25	12



FORCHETTONE 3 PUNTE MULTIUSO

3 prong fork - Fourchette à 3 dents

Mehrzweckgabel mit 3 Zinken - Tenedor 3 púas multiuso

Cod. 07600288

cm	(Euro pcs)	master
30	8,80	12



FORCHETTONE INSALATA

Salad fork - Fourchette à salade

Salatgabel - Tenedor ensalada

Cod. 07600015

cm	(Euro pcs)	master
28	9,80	12

CUCCHIAIONE MULTIUSO*Serving spoon - Cuiller à servir**Serving spoon - Cuiller à servir*

Cod. 07600059

cm	(Euro pcs)	master
30	9,80	12

**CUCCHIAIONE MULTIUSO FORATO***Perforated spoon - Cuiller perforé**Servierlöffel mit Loechern - Cuchara servir con agujeros*

Cod. 07600259

cm	(Euro pcs)	master
30	10,45	12

**FORCHETTONE PER VASSOIO***Serving fork - Fourchette à servir**Serviergabel - Tenedor servir*

Cod. 07600033

cm	(Euro pcs)	master
20	5,10	12

**CUCCHIAIO***Serving spoon - Cuiller à servir**Servierlöffel - Cuchara servir*

Cod. 07600040

cm	(Euro pcs)	master
20	5,10	12





FORCHETTONE SERVIRE PER VASSOIO

*Serving fork - Fourchette à servir
Serviergabel - Tenedor servir*

Cod. 07600088

cm	(Euro pcs)	master
24	6,80	12



CUCCHIAIONE SERVIRE

*Serving spoon - Cuiller à servir
Servierlöffel - Cuchara servir*

Cod. 07600087

cm	(Euro pcs)	master
24	6,80	12



FORCHETTONE INSALATA

*Salad fork - Fourchette à salade
Salatgabel - Tenedor ensalada*

Cod. 076000CF

cm	(Euro pcs)	master
24	8,35	12

CUCCHIAIONE MULTIUSO FORATO

Perforated spoon - Cuiller perforé
Servierlöffel mit Lochern - Cuchara servir con agujeros
Cod. 07600287

cm	(Euro pcs)	master
30	7,90	12



CUCCHIAIO MARMELLATA/MIELE

Jam/honey spoon - Cuiller confiture/miel
Marmelade/Honig Löffel - Cuchara marmelada/miel
Cod. 076000CN

cm	(Euro pcs)	master
30	2,60	12



Cottura

Cooking
Cuisson
Küchen
Cocción



Gas
Gas
Gaz
Gas
Gas

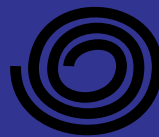

Elettriche a spirale
Electricity radiant ring
Plaque électrique à spirales
Elektrische Spiralheizung
Eléctrica con espirales



Elettriche a piastra
Electricity solid hob
Plaque électrique
Elektrische Platteheizung
Eléctrica lisa



Vetroceramica
Electricity Radiant plate
in glass ceramic
Vitrocéramique
Ceran
Vidrocerámica

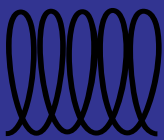

Induzione
Induction
Induction
Induktion
Inducción

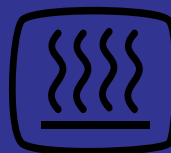

Forno
Oven
Four
Ofen
Horno



Per alimenti
Suitable for foodstuffs
Apte au contact avec les aliments
Für Lebensmittel
Apto para alimentos

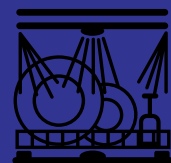

Garantito per lavastoviglie
Dishwasher safe
Inalterable dans lave-vaisselle
Spuelmaschinenfest
Apto para lavavajillas

Expo Satinato



inox
18/10

PENTOLA

Pot - Marmite - Suppentopf - Olla

Cod. 306003..

Ø cm	h cm	Lt	Euro
20	20	6¼	56,85
24	24	10¾	71,30
28	25	15¼	96,90
30	30	21¼	126,70
32	30	25¾	144,75
34	34	30¾	163,40
36	36	36½	189,70
40	38	47¾	214,10
45	45	71½	273,50



CASSERUOLA FONDA 2 MANIGLIE

Deep casserole - Casserole avec 2 poignées - Fleischtopf - Cacerola honda 2 mangos

Cod. 306005..

Ø cm	h cm	Lt	Euro
20	12	3¾	45,15
24	14	6¼	61,10
28	16	9¾	70,90
30	17	12	85,30
32	18	14½	116,60
34	19	17¼	120,65
36	21	21¼	137,75
40	23	28¾	159,95
45	26	41¼	180,60
50	30	58¾	229,20



CASSERUOLA MEZZA FONDA 2 MANIGLIE

Low casserole - Casserole mi-haute avec 2 poignées - Bratentopf - Cacerola baja 2 mangos

Cod. 306009..

Ø cm	h cm	Lt	Euro
24	9,5	4¼	52,00
28	11	6¾	75,30
30	12	8½	77,50
32	13	10½	91,90
34	13,5	12¼	112,95
36	14,5	14¾	123,70
40	16	20	142,95
45	18	28½	165,20
50	20	39¼	199,15





CASSERUOLA MEZZA FONDA CON MANICO

Deep casserole - Casserole avec 1 manche - Fleischtopf - Cazo bajo 1 mangos

Cod. 306010..



Ø cm	h cm	Lt	Euro
16	7,5	1¼	30,55
20	8,5	2¼	43,30
24	9,5	4¼	47,40

CASSERUOLA FONDA CON MANICO

Saucepan - Casserole haute avec manche - Stielkasserolle - Cazo con mango

Cod. 306006..



Ø cm	h cm	Lt	Euro
16	10	2	31,00
20	12	3¾	42,70

CASSERUOLA FONDA CON MANICO E MANIGLIA

Saucepan - Cass. haute avec manche et poignée - Stielkasserolle mit Griff - Cazo con mango y asa

Cod. 306007..



Ø cm	h cm	Lt	Euro
24	14	6¼	60,90
28	16	9¾	70,20



CASSERUOLA CONICA PESANTE

Conical casserole - Casserole conique - Konische Kasserolle, schwere Ausführung - Cazo conico
Cod. 306012..

Ø cm	h cm	Lt	Euro
16	6	1	34,30
18	6,5	1 $\frac{1}{3}$	37,25
20	7	1 $\frac{3}{4}$	44,20
24	7,5	2 $\frac{3}{4}$	52,30



TEGAME 2 MANIGLIE

Frying pan 2 handles - Poêle avec 2 poignées - Pfanne mit 2 Griffen - Paellera 2 asas
Cod. 306023..

Ø cm	h cm	Euro
24	5	55,75
28	6	69,10
30	7	76,30
32	7	82,30
34	7	91,25
36	7	98,20
40	7,5	107,40
45	8,5	141,70
50	9	160,40



PADELLA CON MANICO

Frying pan - Poêle avec manche - Stielpfanne mit Griff - Sarten con mango
Cod. 306026..

Ø cm	h cm	Euro
24	5	61,90
28	6	76,10





PADELLA CON MANICO E MANIGLIA

Frying pan with counter handle - Poêle avec manche et poignée - Stielpfanne mit Griff - Sarten con mango y asa

Cod. 306026..



Ø cm	h cm	Euro
30	7	91,35
32	7	95,90
34	7	103,25
36	7	110,80
40	7,5	119,80
45	8,5	152,70

COPERCHIO

Lid - Couvercle - Deckel - Tapa

Cod. 306030..



Ø cm	Euro
20	14,40
24	16,05
28	19,00
30	21,25
32	24,97
34	27,66
36	30,65
40	36,50
45	42,30
50	53,10



Etichetta personalizzata per la linea
Tender

Tender Custom label



inox
18/10



Speedy-Pasta

CUOCIPASTA COMPLETO

4 SETTORI

Composto da:
pentola, 1 coperchio
1 settore lungo,
3 settori corti

Pasta pot :
1 pot, 1 lid,
1 long section colander
3 short section colanders

Cuiseur de pâtes:
1 marmite, 1 couvercle,
1 Secteur cuit-pâtes long,
3 Secteur cuit-pâtes court

Nudelkocher:
1 Suppentopf, 1 Deckel,
1 Nudelsiebeinsatz lang,
3 Nudelsiebeinsatz kurz

Cuece-pasta:
1 Olla, 1 Tapa,
1 Sector colador alto,
3 Sector colador bajo
Cod. 3390Q404



cm	h cm	Euro
70x38	29	388,62

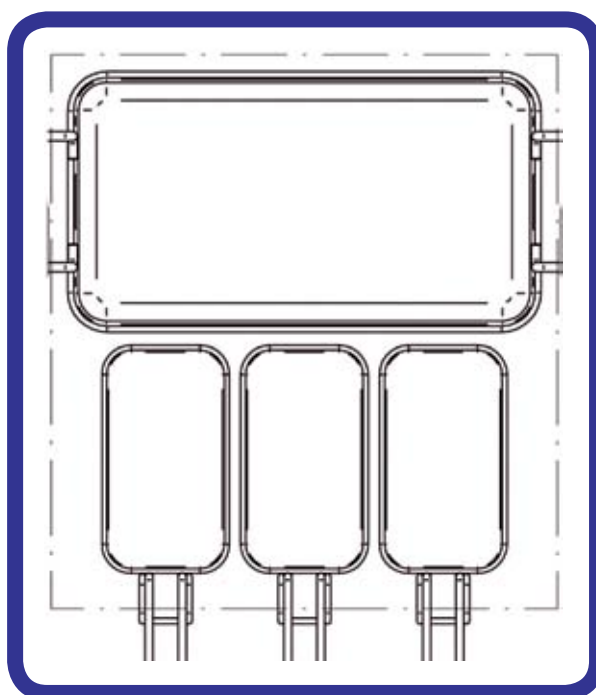



CUOCIPASTA COMPLETO

4 SETTORI

Composto da: 1 pentola, 1 coperchio, 6 settori corti

Pasta pot: 1 pot, 1 lid, 6 short section colanders

Cuiseur de pâtes: 1 marmite, 1 couvercle, 6 Secteur cuit-pates court

Nudelkocher: 1 Suppentopf, 1 Deckel, 6 Nudelsiebeinsatz kurz

Cuece-pasta: 1 Olla, 1 Tapa, 6 Sector colador bajo

Cod. 3390Q406

cm	h cm	Euro
70x38	29	431,90

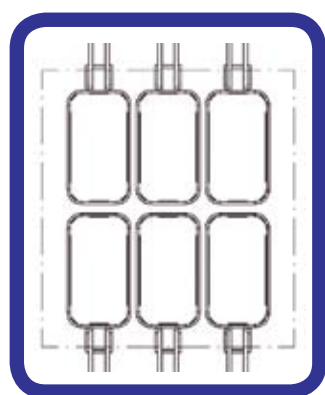

CUOCIPASTA COMPLETO

2 SETTORI

Composto da: 1 pentola, 1 coperchio, 2 settori lunghi

Pasta pot: 1 pot, 1 lid, 2 long section colanders

Cuiseur de pâtes: 1 marmite, 1 couvercle, 2 Secteur cuit-pates long

Nudelkocher: 1 Suppentopf, 1 Deckel, 2 Nudelsiebeinsatz lang

Cuece-pasta: 1 Olla, 1 Tapa, 2 Sector colador alto

Cod. 3390Q402

cm	h cm	Euro
70x38	29	350,00

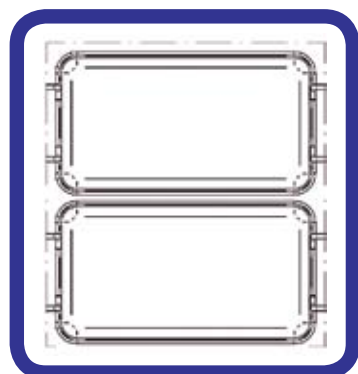

inox
18/10



Speedy-Pasta



PENTOLA QUADRATA

Pot - Marmite - Suppentopf - Olla

Cod. 3390Q334

cm	h cm	Lt	Euro
38,3x35,4	23,7	22	119,08



COPERCHIO CON SPACCO

Lid - Couvercle - Deckel - Tapa

Cod. 3390QS34

cm	h cm	Euro
35,5x32,5	9,4	61,74



SETTORE GRANDE

Long section colander - Secteur cuit-pates long

Nudelsiebeinsatz lang - Sector colador alto

Cod. 3390Q9A1

cm	h cm	Lt	n. persone n. people	Euro
30x14	18	6,6	6	83,38



SET 3 SETTORI PICCOLI

Short section colander - Secteur cuit-pates court

Nudelsiebeinsatz kurz - Sector colador bajo

Cod. 3390Q9A3

cm	h cm	Lt	n. persone n. people	Euro
14x10,5	18	2,3	1-2	132,10

Tender



inox
18/10

PENTOLA

Pot - Marmite - Suppentopf - Olla

Cod. 339003..

Ø cm	h cm	Lt	Euro
20	18	5,50	49,45
24	24	10,75	63,95
28	28	17,00	81,70
30	30	21,25	95,15
32	32	25,75	112,10
34	34	30,75	130,90
36	36	36,50	151,00
40	40	50,25	188,80
45	40	63,50	232,75



CASSERUOLA FONDA 2 MANIGLIE

Deep casserole - Casserole avec 2 poignées - Fleischtopf - Cacerola honda 2 mangos

Cod. 339005..

Ø cm	h cm	Lt	Euro
20	12	3,75	41,60
24	14,5	6,25	54,40
28	16	9,75	69,10
30	17	12,00	75,40
32	19,5	15,70	91,50
36	21,5	21,25	112,50
40	24	30,00	126,00
45	27	42,75	148,60
50	30	58,75	203,20



CASSERUOLA MEZZA FONDA 2 MANIGLIE

Low casserole - Casserole mi-haute avec 2 poignées - Bratentopf - Cacerola baja 2 mangos

Cod. 339009..

Ø cm	h cm	Lt	Euro
24	8	3,50	51,10
28	9,5	5,75	60,50
32	11	8,75	87,90
36	13	13,25	109,40
40	14,5	18,00	126,80
45	15,5	25,40	147,75
50	19	37,25	204,70





CASSERUOLA MEZZA FONDA CON MANICO

Deep casserole - Casserole avec 1 manche - Fleischtopf - Cazo bajo

Cod. 339010..



Ø cm	h cm	Lt	Euro
16	6,5	1,25	28,90
20	7,5	2,25	38,25
24	8	3,50	47,10

CASSERUOLA FONDA CON MANICO

Saucepan - Casserole haute avec manche - Stielkasserolle - Cazo alto

Cod. 339006..



Ø cm	h cm	Lt	Euro
16	9,5	2,00	29,60
20	12	3,75	43,15

CASSERUOLA FONDA CON MANICO E MANIGLIA

Saucepan - Cass. haute avec manche et poignée - Stielkasserolle mit Griff - Cazo alto con mango y asa

Cod. 339007..



Ø cm	h cm	Lt	Euro
24	14,5	6,25	62,20
28	16	9,75	70,20

CASSERUOLA CONICA

Conical casserole - Casserole conique - Konische Kasserolle, schwere Ausführung - Cazo conico

Cod. 339012..



Ø cm	h cm	Lt	Euro
16	6	1,00	28,50
18	6	1,33	31,50
20	6,5	1,75	34,80
24	7,5	2,75	41,50

PADELLA CON MANICO

Frying pan - Poêle avec manche - Stielpfanne mit Griff - Sarten con mango

Cod. 339025..



Ø cm	h cm	Euro
24	5	58,80
28	5,5	83,10



PADELLA CON MANICO E MANIGLIA

Frying pan with counter handle - Poêle avec manche et poignée - Stielpfanne mit Griff - Sarten con mango y asa
Cod. 339026..

Ø cm	h cm	Euro
32	6	91,40
36	6	105,60
40	6	114,50
45	6,5	137,80



TEGAME 2 MANIGLIE

Frying pan 2 handles - Poêle avec 2 poignées - Pfanne mit 2 Griffen - Paellera 2 asas.
Cod. 339023..

Ø cm	h cm	Euro
24	5	56,40
28	5,5	66,20
32	6	76,50
36	6	89,85
40	6	94,80
45	6,5	125,00
50	8	147,60



COPERCHIO

Lid - Couvercle - Deckel - Tapa
Cod. 339030..

Ø cm	Euro
20	12,15
24	12,85
28	14,65
30	16,10
32	17,70
34	18,95
36	19,50
40	22,60
45	26,35
50	29,30

▶ INOX 18% CROMO



inox
18/10



Tender

PADELLA SAUTÉ CON MANICO RIVETTATO

Sauté Frying pan - Sauteuse - Stielpfanne Sauté - Sarten Sauté

Cod. 33903B..



NEW

Ø cm	h cm	Euro
20	4,3	42,90
24	5	49,20
28	5,7	58,56
30	6	62,10
32	6	70,90
36	7	79,90

PADELLA SAUTÉ ANTIADERENTE CON MANICO

*Non-stick Sauté pan - Sauteuse antiadhérente - Antihftbeschichtete Pfanne
"Sauté" mit Stiel - Sartén salud antiadherente con mango*

Cod. 33913B..



NEW

Ø cm	h cm	Euro
20	4,3	58,90
24	5	67,30
28	5,7	77,18
30	6	84,86
32	6	99,90
36	7	114,90



PADELLA BASSA CON ANTIADERENTE GREBLON

Aluminium non-stick frying pan

Sartén antiadherente de aluminio

Cod. 350925..

Ø cm	h cm	Lt	master	Euro
20	4,0	1,0	6	16,15
24	4,5	1,6	6	22,60
28	5,2	2,6	6	28,15
32	6,0	4,0	6	34,25
36	6,7	5,7	6	41,20
40	7,5	7,9	6	48,70
45	8,4	11,2	6	60,95



PADELLA ALTA CON ANTIADERENTE GREBLON

Aluminium non-stick deep frying pan

Sartén honda antiadherente de aluminio

Cod. 3509C5..

Ø cm	h cm	Lt	master	Euro
20	4,7	1,2	6	17
24	5,4	2,0	6	23,70
28	6,3	3,3	6	29,20
32	7,2	5,0	6	34,80
36	8,1	7,1	6	43,45





Excalibur

Cod. 3610

- Produzione made in Italy.
- Alto spessore.
- Prodotto in ferro (Fe).
- Adatto a tutti i tipi di cucina.
- Ottimo per l'induzione.
- Manico ergonomico in acciaio rivettato.
- Nickel Free.
- Linea professionale adatta per: frittura, cottura alla piastra, arrostitura, brasatura, caramellatura.

- Made in Italy.*
- High tickness.*
- Item made in steel (Fe).*
- Suitable for all kind of cooktops.*
- Perfect for Induction use.*
- Riveted Ergonomic stainless steel handle.*
- Nickel Free.*
- Professional Series useful for: frying, grill cooking, oast cooking, brazing cooking, caramelization.*

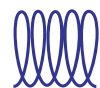

PADELLA

Frying pan

Sartén

Cod. 361054..

Ø cm	h cm	Lt	Euro
12*	2,2	0,20	19,50
18*	3,35	0,63	22,50
20	3,75	0,85	22,85
22*	3,7	1,07	24,80
24	4	1,35	25,60
26	4,35	1,75	29,30
28	4,7	2,20	31,00
30*	5	2,74	33,95
32	5,4	3,30	35,60
34	5,75	4,03	40,90



NEW*

PADELLA FONDA

Deep Frying pan

Sartén honda

Cod. 3610C5..

Ø cm	h cm	Lt	Euro
24	7,65	2,70	35,20
28	8,6	4,15	44,95



NEW

TEGAME

Frying pan 2 handles

Rustidera

Cod. 36102332..

Ø cm	h cm	Lt	Euro
32	5,4	3,30	46,20



NEW

inox
18/10



Excalibur



NEW

CREPIERE

Crêpe frying pan

Crepiera

Cod. 361045..

Ø cm	h cm	Lt	Euro
20	1,25	0,36	22,80
24	1,5	0,60	25,00
28	1,75	0,90	29,10



WOK 2 MANIGLIE

Wok with 2 handles

Wok de 2 asas

Cod. 36109M36

Ø cm	h cm	Lt	Euro
36	11,9	7,1	86,75



WOK

wok

wok

Cod. 36109F34

Ø cm	h cm	Lt	Euro
34	9,4	4,75	81,80

Roasting Pan Plat à Rôti Fleischkasten Rustidera Horno

TEGLIA RETTANGOLARE

Roasting Pan - Plat à Rôti

Fleischkasten - Rustidera Horno

Cod. 548128..

cm	h cm	Euro
25x18	7	37,20
30x21	7	42,10
35x25	7	47,30



COPERCHIO PER TEGLIA

Lid for roasting pan - Couvercle pour plat à rôti

Deckel für Fleischkasten - Tapa para rustidera horno

Cod. 548128..

cm	Euro
25x18	22,20
30x21	24,50
35x25	29,70





TEGLIA SATINATA

Satin roasting pan - Plat à rôti satiné - Fleischkasten satiniert - Rustidera horno satinado

Cod. 509003..



cm	h cm	Euro
40x30	10	64,00
50x35	9	80,00
60x40	8	107,00

COPERCHIO SATINATO PER TEGLIA SOVRAPPONIBILE

Satin lid for roasting pan - Couvercle satiné pour plat à rôti -
Deckel satiniert für Fleischkasten - Tapa satinado para rustidera horno

Cod. 509006..



cm	Euro
40x30	46,50
50x35	51,15
60x40	77,70

Preparazione

Preparation
La préparation
Vorbereitung
Preparación



Per alimenti
Suitable for foodstuffs
Apte au contact avec les aliments
Für Lebensmittel
Apto para alimentos

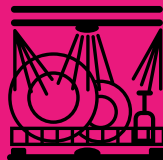

Garantito per lavastoviglie
Dishwasher safe
Inalterable dans lave-vaisselle
Spelmaschinenfest
Apto para lavavajillas

Bagnomaria

Bain-marie Bain-marie Bain-marie Baño maria

BAGNOMARIA CILINDRICO CON MANICO

*Cylindrical bain-marie with handle - Bain-marie cylindrique avec manche
Bain-marie zylindrisch mit Stiel - Baño maria cilindrico con mango*

Cod. 509031..



Ø cm	h cm	Lt	Euro
14	16	2½	33,80
16	18	3½	36,70
18	20	5	43,60
20	22	7	55,20

BAGNOMARIA QUADRATO

Square bain-marie - Bain-marie carré - Bain-marie viereckig - Baño maria cuadrado



Cod.	cm	h cm	Lt	Euro
50903003	16	16	3½	44,90
50903005	16	25	5	58,50

COPERCHIO BAGNOMARIA QUADRATO

Square lid - Couvercle carré - Deckel viereckig - Tapa cuadrada

Cod. 50903316



cm	h cm	Euro
16	16	11,10

SCALDAPASTA A SETTORI

Section colander - Passoire à secteurs - Einsatz - Sección para colador

Cod. 509012..

	Ø cm	h cm	Euro
1/3	34	20,5	48,30
1/4	40	26,5	50,50



CONO CINESE

Chinois - Chinois - Spitzsieb - Colador chino

Cod. 785003..

	Ø cm	Euro
50	11,5	14,50
51	17	21,00
52	19	23,50
53	20	26,95
54	22	34,80
55	24	36,50
56	26	41,45



PASSABRODO

Strainer - Passoire pour bouillon - Suppen-filtersieb - Pasacaldo

Cod.	Ø cm	h cm	Euro
71000106	6,3	1,8	4,85
71000114	13	5,5	13,25
71000116	16,5	6,5	19,40
71000118	18,5	8,0	23,55



INSALATIERA BASE PIANA SENZA MANIGLIE*Salad bowl without handles - Saladier sans poignées - Salatschüssel ohne Griffe - Ensaladera sin asas***Cod. 509038..**

Ø cm	h cm	Lt	Euro
16	7	1	14,80
18	8	1½	18,20
22	10	2½	22,55
24	11	3½	25,60
26	12	4½	31,55
28	13	5½	35,90
34	16	12¾	70,20
40	19	16	98,40

INSALATIERA CONICA BORDATA*Conical salad bowl - Saladier conique - Konische Salatschüssel - Ensaladera conica***Cod. 509037..**

Ø cm	h cm	Lt	Euro
16	6	1/2	7,70
18	6,8	3/4	9,55
22	7,2	1	13,85
24	7,6	1⅓	16,30
28	10	2¾	20,15
32	11	4¾	27,00
36	13,2	6¾	32,25
40	13,7	8⅓	38,00

BASTARDELLA BASE PIANA CON MANIGLIE*Salad bowl with handles - Saladier sans poignées - Salatschüssel ohne Griffe - Caldero con asas***Cod. 509036..**

Ø cm	h cm	Lt	Euro
16	7	1	19,80
18	8	1½	22,60
22	10	2½	28,50
24	11	3½	31,65
26	12	4½	37,40
28	13	5½	41,75
34	16	12¾	76,80
40	19	16	101,95

FORMA CRÈME-CARAMEL

Crème caramel mould - Moule pour crème-caramel - Form für crème caramel - Molde para flan de caramelo

Cod. 50953107

Ø cm	h cm	Lt	Euro
7	7	0,27	7,95



MATTARELLO

Rolling - Rouleau à pâtisserie - Wellholz - Rodillo de pastelería

Cod. 50908148

lunghezza cm	Euro
48	49,00



IMBUTO

Funnel - Entonnoir - Trichter - Embudo

Cod. 50907816

Ø cm	Euro
16	21,80



IMBUTO

Funnel - Entonnoir - Trichter - Embudo

Cod. 50907820

Ø cm	Euro
20	26,00



SPREMIAGRUMI

Citrus squeezer - Presse-citron - Zitronenpresse - Exprimidor

Cod. 50953C00

master	Euro
6	17,20



Finitura esterna ed interna lucida Outside and inside satin finish Finition extérieure et intérieure satinée Außen und innen satiniert Externo y interno satinado



SETACCIO FARINA

Flour strainer - Passoire à farine
Mehlsieb - Cedazo harina

Cod. 509055..

mm	Ø cm	Euro
2,5x1,4	21	17,50
	30	23,30
	35	25,50



SETACCIO VELO

Strainer - Passoire
Mehlsieb - Cedazo

Cod. 509056..

mm	Ø cm	Euro
1,5x1	21	18,20
	30	22,50
	35	25,50



SETACCIO PANE

Bread strainer - Passoire à pain
Mehlsieb - Cedazo pan

Cod. 509057..

mm	Ø cm	Euro
2x2	30	23,50
	35	25,50



SETACCIO PESCE

Fish strainer - Passoire à poisson
Mehlsieb - Cedazo pescado

Cod. 509058..

mm	Ø cm	Euro
6x6	30	24,50
	35	28,00

Presentazione

Presentation
Présentation
Präsentation
Presentación



Per alimenti
Suitable for foodstuffs
Apte au contact avec les aliments
Für Lebensmittel
Apto para alimentos

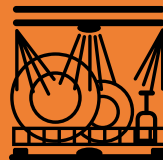

Garantito per lavastoviglie
Dishwasher safe
Inalterable dans lave-vaisselle
Spelmaschinenfest
Apto para lavavajillas

Oval tray Plateau oval Einfache ovale platte Fuente ovalada

PIATTO OVALE PORTATA BORDATO PESANTE

Edged oval tray - Plateau oval avec bord - Ovale Bratenplatte - Fuente ovalada rebordeada

Cod. 509316..



cm	spess. mm	master	Euro
26x19	0,7	10	16,30
31x21	0,7	10	17,30
36x25	0,7	10	19,90
42x29	0,7	10	23,90
47x34	0,8	10	30,40
53x35	0,8	10	41,30
60x39	0,8	-	49,50
70x46	1,2	-	135,70
85x58	1,2	-	360,00

Cod. 50931699

cm	spess. mm	master	Euro
100x68	1,2	-	437,50

PIATTO OVALE PORTATA BORDATO

Edged oval tray - Plateau oval avec bord - Serviertablett - Fuente ovalada rebordeada

Cod. 509333..



cm	spess. mm	master	Euro
19x15	0,6	10	10,90
23x16	0,6	10	13,00
26x20	0,6	10	15,30
29x22	0,6	10	16,00

PIATTO OVALE PORTATA NORMALE

Oval tray - Plateau oval - Einfache ovale Platte - Fuente ovalada

Cod. 509314..



cm	spess. mm	master	Euro
32x22	0,7	10	17,70
40x29	0,7	10	25,00
48x32	0,7	10	29,50

PIATTO OVALE GASTRONOMICO

Oval tray - Plateau oval - Tiefe ovale Platte - Fuente ovalada

Cod. 50931942

cm	spess. mm	master	Euro
42x31	0,7	10	33,70



PIATTO OVALE PORTATA PESCE

Fish tray - Plat oval à poisson - Fischplatte - Fuente ovalada pescado

Cod. 509336..

cm	spess. mm	master	Euro
55x24	1,0	-	38,10
70x29	1,0	-	55,30
85x33	1,2	-	111,30



Cod. 50933699

cm	Spess. mm	master	Euro
100x34	1,2	-	137,00

VASSOIO TONDO BORDATO

Round edged tray - Plateau rond bordé - Rundes Tablett - Bandeja redonda rebordeada

Cod. 509330..

Ø cm	spess. mm	master	Euro
30	0,7	10	20,80
35	0,8	10	26,80



Vassoi Gratin

Tray Plateau Tablett Bandeja

VASSOIO GRATIN

Serving tray gratin - Plat à gratin - Gratinplatte - Bandeja gratin

Cod. 509368..

cm	spess. mm	master	Euro
40x21	1,0	-	38,00
45x23	1,0	-	45,00
50x27	1,0	-	52,00



Vassoio da portata

Tray Plateau Tablett Bandeja

VASSOIO RETTANGOLARE

Rectangular tray - Plateau rectangulaire - Tablett - Bandeja rectangular

Cod. 509312..



cm	spess. mm	master	Euro
25x20	1,0	10	19,60
32x25	1,0	10	26,40
36x29	1,0	10	29,60
40x33	1,0	10	33,20
45x35	1,0	-	40,50
48x37	1,0	-	43,30
60x47	1,0	-	67,20

VASSOIO RETTANGOLARE CON MANIGLIE

Rectangular tray with two handles - Plateau rectangulaire à deux manches

Tablett mit zwei Griffen - Bandeja rectangular con asas

Cod. 509313..



cm	spess. mm	master	Euro
48x37	1,0	-	68,50
60x47	1,0	-	94,40

VASSOIO RETTANGOLARE CON MANIGLIE

Magna rectangular tray with two handles - Plateau rectangulaire Magna à deux manches

Magna Tablett mit zwei Griffen - Bandeja rectangular con dos asas

Cod. 509313..



cm - h cm	spess. mm	master	Euro
44X29X3	1,0	-	59,60
50X33X3	1,0	-	90,00

VASSOIO RETTANGOLARE PITAGORA 1929

Rectangular tray - Plateau rectangulaire - Tablett - Bandeja rectangular

Cod. 509373..



cm	Euro
44x29	90,70
50x33	103,20

VASSOIO TONDO BORDATO

Round edged tray - Plateau rond bordé - Rundes Tablett - Bandeja redonda rebordeada

Cod. 509329..

Ø cm	spess. mm	master	Euro
34	0,7	10	28,00
38	0,7	10	32,00
42	0,8	10	40,00
46	0,8	-	46,50
53	0,8	-	60,30



VASSOIO TONDO BORDATO CON MANIGLIE

Round edged tray with handles - Plateau rond bordé avec poignées

Rundes Tablett mit Griffen - Bandeja redonda rebordeada con asas

Cod. 509327..

Ø cm	spess. mm	master	Euro
42	0,8	-	121,50
46	0,8	-	128,40
53	0,8	-	142,20



VASSOIO RETTANGOLARE PER PASTICCERIA

Pastry deep tray - Plateau rectangulaire à pâtisserie - Tiefes Kuchentablett - Bandeja rectangular pastelera

Cod. 50933827

cm	spess. mm	master	Euro
27x20	0,6	-	13,30



Vassoi impilabili

Tray Plateau Tablett Bandeja

VASSOIO GN 1/1 IMPILABILE

Tray - Plateau - Tablett - Bandeja GN 1/1 apilable

Cod. 50933456

cm - h cm	master	Euro
53x32x7	10	94,90



Bacinelle per pasticceria

Deet tray Plateau Tiefes Tablett Bandeja

BACINELLA PER PASTICCERIA

Pastry deep tray - Plateau à pâtisserie - Einfaches tiefes Tablett - Bandeja honda pastelera

Cod. 509339..



cm - h cm	spess. mm	master	Euro
25x18x2	0,6	10	16,10
30x22x2	0,7	10	22,50
35x25x2,5	0,8	10	26,00

BACINELLA PER PASTICCERIA

Pastry deep tray - Plateau à pâtisserie - Einfaches tiefes Tablett - Bandeja honda pastelera

Cod. 509339..



cm - h cm	spess. mm	master	Euro
29x21x2	0,8	10	19,40
58x21x2	1,0	-	35,90

Salsiere

Sauce boat Sauciere Sauciere Salsera

SALSIERA CON BASE

Sauce boat with foot - Saucière sur pied - Sauciere mit Fuß - Salsera con base

Cod. 509153..



cl	master	Euro
9	10	8,10
14	10	10,80
22	10	14,95
28	10	16,60
45	10	19,20

SALSIERA SENZA BASE

Sauce boat without foot - Saucière sans pied - Sauciere ohne Fuß - Salsera sin base

Cod. 50915420



cl	master	Euro
20	10	11,90

Zuppiera

inox
18/10

Soup bowl Soupière Suppenterrine Sopera

ZUPPIERA

Soup bowl - Soupière - Suppenterrine - Sopera

Cod. 308772..

Ø cm	h cm	Lt	Euro
18	10	1,5	28,00
22	12	3	39,00
24	13	4	40,80
26	14	4,75	48,50
28	15	6	55,80



COPERCHIO PER ZUPPIERA

Lid for soup bowl - Couvercle pour soupière - Deckel für Suppenterrine - Tapa para sopera

Cod. 308775..

Ø cm	Euro
18	22,50
22	29,30
24	30,50
26	31,50
28	33,35



Cloche e Burro

PORTA BURRO DA TAVOLA

Butter dish - Porte beurre - Butterschale - Mantequillera

50933111

Ø cm	h cm	Euro
12,5	8,7	22,65



CLOCHE SEMISFERICA CON POMOLO

Semispheric cloche with knob - Cloche hémisphérique avec pommeau
Speiseglocke kugelförmig mit Griff - Cloche semiesferica con pomo

Cod. 509322..



Ø cm	h cm	for round tray Ø cm	Euro
22	12	30	32,50
24	13	30	35,00
26	14	35	41,50
28	15	35	47,50

CLOCHE ROTONDA CON POMOLO

Round cloche with knob - Cloche ronde avec pommeau
Speiseglocke mit Griff - Cloche redonda con pomo

Cod. 509323..



Ø cm	for round tray Ø cm	Euro
25	30	38,00
30	35	49,50

CLOCHE OVALE CON POMOLO

Oval cloche with knob - Cloche ovale avec pommeau
Speiseglocke oval mit Griff - Cloche ovalada con pomo

Cod. 509321..



cm	for oval tray Ø cm	Euro
32	36	49,15
42	47	61,20

OLIERA 5 PEZZI NOUVELLE CUISINE

5 pc cruet set - Ménagère 5 pièces
Menage 5 Tlg - Vinagreras 5 piezas

Cod. 50943305

cm - h cm

Euro

17,1x14,5x20,5

71,00



OLIERA SALE/PEPE 4 PEZZI NOUVELLE CUISINE

4 pc cruet salt/pepper set - Ménagère avec sel et poivre
Menage 4 Tlg mit Pfeffer/Salz - Vinagreras con pimentero y salero

Cod. 50943304

cm - h cm

Euro

17,1x14,5x20,5

60,50



OLIERA SALE/PORTASTECCHI 4 PEZZI NOUVELLE CUISINE

4 pc cruet salt/toothpick set - Ménagère avec saliere et cure-dents
Menage mit Salz und Zahnstocherfl - Vinagreras con salero y palillos

Cod. 509433A4

cm - h cm

Euro

17,1x14,5x20,5

60,50



OLIERA 2 PEZZI NOUVELLE CUISINE

2 pc cruet set - Ménagère 2 pièces
Menage 2 Tlg - Vinagreras 2 piezas

Cod. 50943302

cm - h cm

Euro

15x9,2x20,5

45,00

SALE/PEPE E PORTASTECCHI NOUVELLE CUISINE

Salt /pepper and toothpicks set - Set à sel/poivre et cure dents
Salz und Pfefferstreuer und Zahnstocherf - Salero con palillo

Cod. 50943510



cm - h cm	Euro
11,5x10x12	51,50

SALE/PEPE NOUVELLE CUISINE

Salt and pepper set - Set à sel et poivre
Menage Salz und Pfefferstreuer - Salero y pimien

Cod. 50943500



cm - h cm	Euro
11x6,8x13,5	30,85

SALE/PORTASTECCHI NOUVELLE CUISINE

Salt and toothpicks set - Set à sel et cure dents
Menage Salz und Zahnstocherfl - Salero y porta palillos

Cod. 509435A0

cm - h cm	Euro
11x6,8x13,5	30,85

FORMAGGERA CON CUCCHIAINO NOUVELLE CUISINE

Cheese bowl with cheese spoon - Fromagère avec cuillère à parmesan
Käsedose mit Käselöffel - Quesera con cuchara

Cod. 50943400



Ø cm - h cm	Euro
11,6x6,8	27,50

Ricambi oliere e formaggere

VETRO OLIERA

Oil/vinegar glass - Burette - Menage - Ampolla

Cod. 97200060

Mod.	Euro
Nouvelle Cousine	7,00



SALVAGOCCIA

Plastic drop-catcher - Protège-goutte - Stöpsel - Protector de gotas

Cod. 97200062

Mod.	Euro
Nouvelle Cousine	0,80



CAPPUCCIO 18/10 PER VETRO OLIERA

18/10 Cup for oil/vinegar glass - Capuchon 18/10 pour burette

Kappe für Menage 18/10 - Capuchón ampolla 18/10

Cod. 97200059

Mod.	Euro
Nouvelle Cousine	3,15



SALINO

Salt/pepper glass - Salière - Salzstreuer - Salero

Cod. 97200061

Mod.	Euro
Nouvelle Cousine	1,90



Ricambi per oliere e formaggi

CAPPUCCIO IN ACCIAIO INOX 18/10 PER SALINO

18/10 Salt cup for salt/pepper glass

Capuchon en acier inoxydable pour salière

Salzstreuerkappe aus Stahl inox

Capuchón salero de acero inoxidable

Cod. 97200058



Mod.

Euro

Nouvelle Cousine

3,00

CAPPUCCIO IN ACCIAIO INOX 18/10 PER PEPE/STUZZICADENTI

18/10 Pepper/toothpicks cup for salt/pepper glass

Capuchon en acier inoxydable pour poivrière

Kappe aus Stahl inox für Pfeffer Salz- und Zahnstocher

Capuchón pimienta/palillos de acero inoxidable

Cod. 97200057



Mod.

Euro

Nouvelle Cousine

3,00

CAPPUCCIO UNIV. INOX 18/10 PER STUZZICADENTI INCARTATI

18/10 Universal toothpicks cup

Capuchon en acier inoxydable 18/10 pour cure-dents

Universalkäppchen zahnstocher

Capuchón univ. Para palillos limpiadientes en empapelados

Cod. 97200053



Mod.

Euro

Nouvelle Cousine

3,00

VETRO PER FORMAGGERA

Cheese bowl glass

Verre pour fromagère

Glas für Käsedose

Cristal para quesera

Cod. 97200035



Mod.

Euro

Nouvelle Cousine

6,90

Secchielli e brocca

Bucket-Pitcher Seau-Cruche Kübel-Krug Cubo-Lanzador

inox
18/10

SECCHIELLO CHAMPAGNE PITAGORA 1929

Champagne bucket - Seau à champagne

Sektkübel - Cubo de champan

Cod. 50954100

Ø cm	h cm	Euro
------	------	------

18	20	88,80
----	----	-------



SECCHIELLO GHIACCIO CON MOLLA PITAGORA 1929

Ice bucket with ice tongs - Seau à glace avec pince

Eiskübel - Cubo de hielo

Cod. 50954000

Ø cm	h cm	Euro
------	------	------

12	12	52,70
----	----	-------



BROCCA TERMICA INOX 18/10

Pitcher - Cruche

Krug - Servidor termo

Cod. 551490..

Lt	Euro
----	------

1	31,00
---	-------

1,5	32,85
-----	-------

2	38,50
---	-------



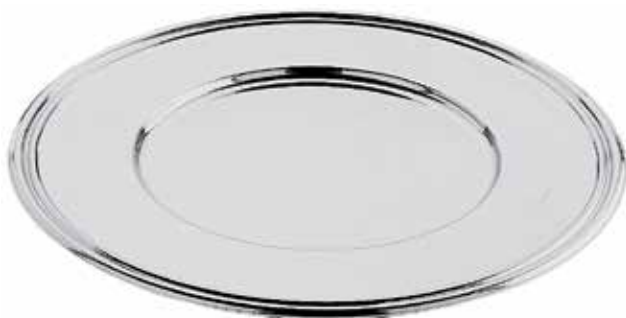

SOTTOPIATTO BERNINI

Underplate - Sous-assiette

Platzteller - Bajo plato

Cod. 50932531

Ø cm	master	Euro
31	20	25,70



SOTTOBOTTIGLIA BERNINI

Bottle coaster - Dessous de bouteille

Flaschenteller - Posa botellas

Cod. 50913714

Ø cm	master	Euro
14	6	15,00



SOTTOBICCHIERE BERNINI

Coaster - Dessous de verre

Gläsernteller - Posa vasos

Cod. 50913611

Ø cm	master	Euro
11	6	11,75

LUMACHIERA

Snails plate - Plat à escargots - Schneckenplatte - Plato para caracoles

Cod. 509155..



Ø cm	posti	Euro
14	6	7,00
20	12	9,00

Vassoi rettangolari

inox
18/10

Rectangular trays Plateaux rectangulaires Rechteck-tablettes Bandejas rectangulares

VASSOIO RETTANGOLARE PASTICCERIA CON CUPOLA

Rectangular tray for pastries

Plateau rectangulaire a patisserie

Rechteckiges tablett 1/1 mit rolltop

Bandeja rectangular para pastelería

Cod. 50950920

cm	h cm	Euro
53x32,5	21,5	105,00



VASSOIO RETTANGOLARE PER FORMAGGI CON TAGLIERE IN POLIETILENE E CUPOLA

Rectangular tray for cheese with polyethylene board

Plateau rectangulaire a fromage avec planche en polyéthylène

Rechteckiges tablett 1/1 mit Polyethylen Schneidebrett

Bandeja rectangular para queso con tabla en polietileno

Cod. 50950940

cm	h cm	Euro
53x32,5	21,5	175,00

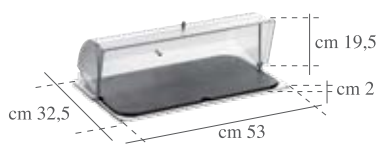

VASSOIO RETTANGOLARE REFRIGERANTE A DOPPIA PARETE PER AFFETTATI CORREDATO DI CONTENITORI REFRIGERATI CON CUPOLA

Rectangular refrigerated tray with double wall for sliced salami and with cooling boxes

Plateau rectangulaire refrigerant a double paroi pour charcuterie avec recipients refrigerants

Rechteckiges kühltablett mitt doppelwand ausgestattet mit kühlbehältern

Bandeja rectangular refrigerante de doble pared para charcuteria con recipientes refrigerantes

Cod. 50950950

cm	h cm	Euro
53x32,5	24	160,00

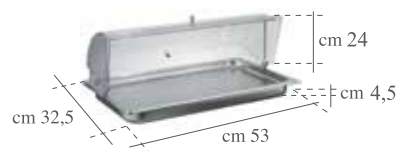

*Diagramma del mantenimento della temperatura
Temperature maintenance diagram*

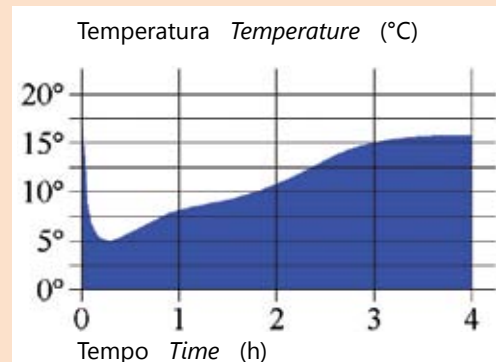

Sistemi refrigeranti

inox
18/10

PORTA YOGURT 19 FORI Ø mm 55 CORREDATO DI REFRIGERANTI

Refrigerated yoghurt dispenser

Porte-yogourt avec réfrigérants

Joghurt-halter mit kühlakku

Porta-yogur con refrigerantes

Cod. 50952947



Ø cm	Lt	Euro
47,5	10	235,00

Diagramma del mantenimento della temperatura
Temperature maintenance diagram

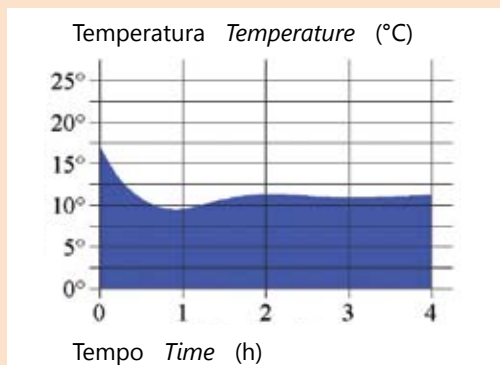

PORTA BURRO REFRIGERABILE

Refrigerated butter tray

Porte-beurre réfrigérable

Butterschale mit kühlakku

Porta-mantequilla refrigerable

Cod. 50933136



Ø cm	Lt	Euro
35	6,5	80,00

Diagramma del mantenimento della temperatura
Temperature maintenance diagram

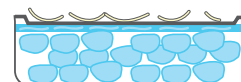
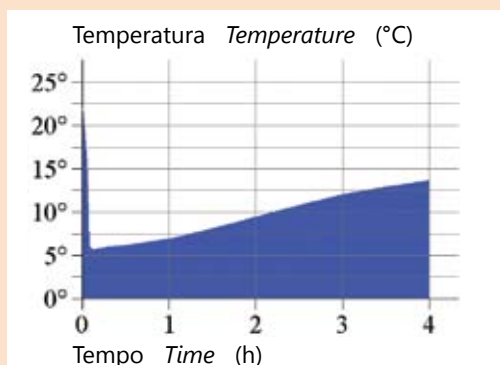

Contenitore ghiaccio
Ice bucket
Recipient a glace
Eisbehälter
Recipiente para hielo



Supreme bowl

COPPA JUMBO SEMISFERICA CON BASE

Jumbo bowl with foot
Coupe jumbo semi-spherique avec base
Champagner bowl
Copa jumbo semiesférica con base
Cod. 509555..



Ø cm	bottles	Euro
28	4	54,50
34	6	90,00
40	8	130,00

ANELLO PORTABICCHIERI PER COPPA JUMBO

Glass holding ring for jumbo bowl
Anneau porte-verres pour coupe jumbo
Ring 28 cm für 8 sektgläser
Aro porta vasos para copa jumbo
Cod. 509551..



Ø cm	glasses	Euro
28	8	30,00
34	12	40,00
40	18	51,00



SUPREME BOWL DOPPIA PARETE CON COPERCHIO E CIOTOLA IN VETRO INFRANGIBILE

Supreme bowl, double wall with lid and unbreakable glass bowl

Supreme bowl double paroi avec couvercle et bol en verre incassable

Supreme bowl doppelwand mit deckel und unzerbrechlicher glasschüssel

Supreme bowl doble pared con tapa y cuenco de vidrio irrompible

Cod.	Ø cm	h cm	Lt	Euro
50951925	26	24	3	101,00
50951934	34	32	5	203,00

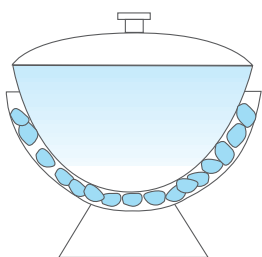

Contenitore ghiaccio
Ice bucket
Recipient a glace
Eisbehälter
Recipiente para hielo



COPERCHIO PER SUPREME BOWL

Lid for supreme bowl

Couvercle pour suprême bowl

deckle für supreme bowl

tapa para supreme bowl

Cod.	Ø cm	Euro
50951926	23	31,80
50951935	31,5	35,00



Porta dolci e muesli

Cake display Etagere Ständer für torten Fuente alta
Muesli holder Porte muesli Dreier müslistation Porta-muesli



PORTA DOLCI 3 POSTI

Cake display
Etagère
Ständer für torten
Fuente alta 3 niveles

Cod. 51001557

cm	h cm	Euro
54x49	18,5	145,00

PORTA MUESLI CON COPERCHIO APRIBILE IN POLICARBONATO

Muesli holder with polycarbonate openable lid
Réipient à muesli avec couvercle ouvrable en polycarbonate
Müsli-halter mit klappdeckel aus polycarbonat
Recipiente para muesli con tapa abrible de policarbonat

Cod. 50951P48



cm	h cm	Euro
48x46	23	217,00



Utensili

Tools

Ustensiles

Zubehör

Utensilios



Per alimenti
Suitable for foodstuffs
Apte au contact avec les aliments
Für Lebensmittel
Apto para alimentos

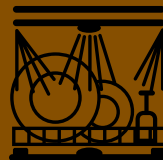

Garantito per lavastoviglie
Dishwasher safe
Inalterable dans lave-vaisselle
Spelmaschinenfest
Apto para lavavajillas

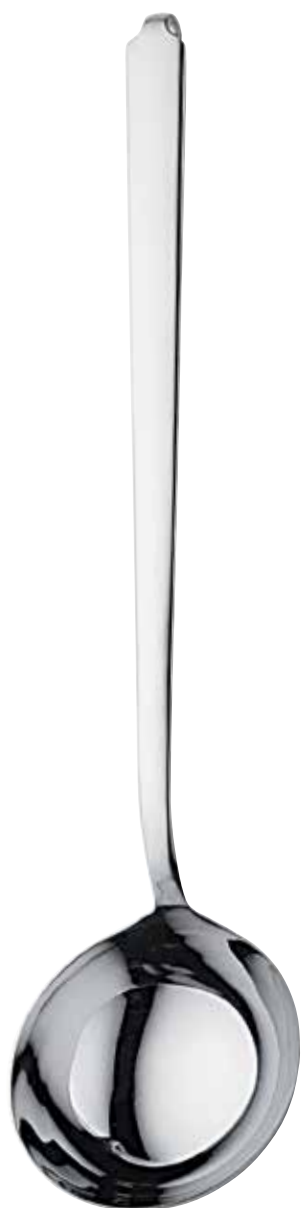

MESTOLO

Ladle
Louche
Suppensöpfer
Cazo

Cod. 509203B0

cm Euro

34,5 15,25

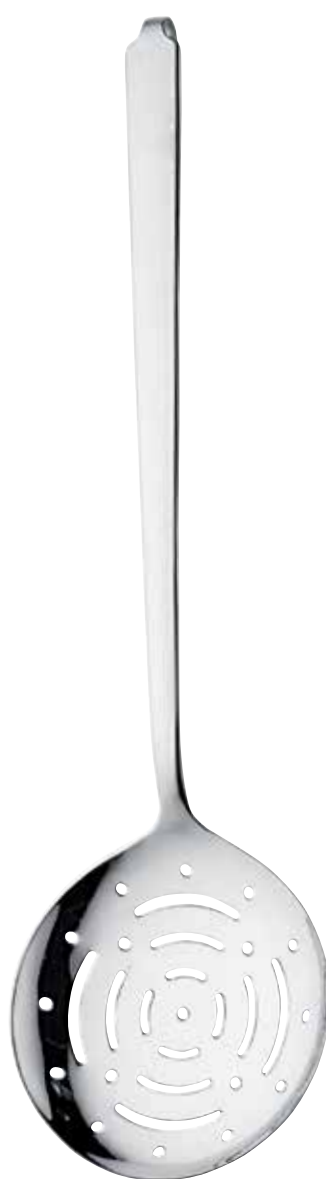

SCHIUMAROLA

Skimmer
Ecumoire
SchaumlöfFel
Espumadera

Cod. 509218B0

cm Euro

36,2 14,90



PALAFRITTO

Spatula
Pelle
Bratenwender
Pala fritos

Cod. 509226B0

cm Euro

34 11,40

**CUCCHIAIONE**

Serving spoon
Cuiller a servir
Bratenlöffel
Cucharon

Cod. 509210B0

cm	Euro
34,5	11,25

**FORCHETTONE**

Serving fork
Fourchette a servir
Fleischgabel
Tenedor una pieza

Cod. 509217B0

cm	Euro
34,5	11,50

**SERVISPAGHETTI**

Spaghetti server
Cuiller spaghetti
Spaghettigabel
Cuchara de servir
para espaguetis

Cod. 509222B0

cm	Euro
33	12,70

inox
18/10

Mestolame unipezzo pesante

Ladles Louches Vorlegeteile Cazos

MESTOLO UNIPEZZO

One-piece ladle - Louche monobloc
Suppenshöpfer einteilig - Cazo una pieza

Cod. 509258..



Ø cm	lungh. cm	Euro
6	28	6,30
8	34	10,00
9	37	10,95
10	37	13,00
11	37	14,55
12	38	20,30
14	40	27,20
16	41	36,60

MESTOLO UNIPEZZO FORATO

Slotted one piece ladle - Louche monobloc avec trous
Löcher Suppenshöpfer einteilig - Cazo una pieza agujers

Cod. 509226..

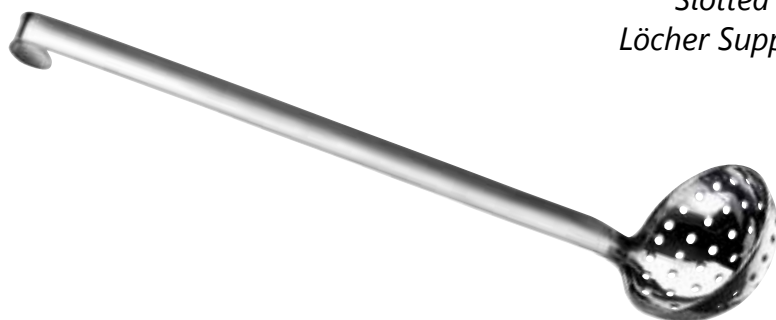

Ø cm	lungh. cm	Euro
6	28	7,00
8	34	10,00
10	37	13,80
12	38	20,20
16	41	37,00

SCHIUMAROLA UNIPEZZO

One-piece skimmer - Ecumoire monobloc
Schaumlöffel einteilig - Espumadera una pieza

Cod. 509269..



Ø cm	lungh. cm	Euro
11	37	10,30
12	38	12,75
14	42	20,20
16	45	27,60
18	49	31,80

Mestolo unipezzo pesante

inox
18/10

MESTOLO UNIPEZZO SALSA

One piece sauce ladle - Sauce louche monobloc

Sauce Löcher Suppenschoffer - Cazo una pieza por salsa

Cod. 50926300

cm	Euro
27	7,00



SPATOLA UNIPEZZO

One piece spatula - Spatule

Spachtel - Espátula

Cod.	cm	Euro
50923910	46	18,20
50923912	55	21,70



PALA FRITTO UNIPEZZO NUOVA FORATURA

One piece spatula - Pelle monobloc

Bratenwender einteilig - Pala fritos una pieza

Cod.	cm	Euro
50923010	46	16,90
50923012	55	22,30



inox
18/10

Mestolo unipezzo pesante



PALA FRITTO UNIPEZZO

*One-piece spatula - Pelle monobloc
Bratenwender einteilig - Pala fritos una pieza*

Cod. 50927700

cm	Euro
----	------

36	10,30
----	-------

CUCCHIAIONE UNIPEZZO

*One-piece serving spoon - Cuiller à servir monobloc
Bratenlöffel einteilig - Cucharon una pieza*

Cod. 50926200

cm	Euro
----	------

35	10,75
----	-------



FORCHETTONE UNIPEZZO

*One-piece serving fork - Fourchette à servir monobloc
Fleischgabel einteilig - Tenedor una pieza*

Cod. 50926500

cm	Euro
----	------

35	10,00
----	-------



NUOVO CUCCHIAIONE FONDO UNIPEZZO

*One piece deep serving spoon - Profond cuiller à servir monobloc
Bratenloffel tief einteilig - Cucharon una pieza profundo*

Cod. 50926700

cm	Euro
46	14,90



FORCHETTONE UNIPEZZO

*One-piece serving fork - Fourchette à servir monobloc
Fleischgabel einteilig - Tenedor una pieza*

Cod. 50926600

cm	Euro
50	18,15



FORCHETTONE UNIPEZZO PESANTE 3 PUNTE

*One-piece 3 prongs serving fork - Fourchette à servir monobloc 3 dents
Fleischgabel einteilig mit 3 zinken - Tenedor una pieza con 3 púas*

Cod. 509267..

cm	Euro
50	25,85
70	34,70



inox
18/10

Fruste

Whisk Fouet Schneebesen Batidor

FRUSTA

Whisk - Fouet

Schneebesen - Batidor

Cod. 509164..



cm	Euro
----	------

25	6,50
----	------

30	7,00
----	------

35	8,00
----	------

40	8,60
----	------

FRUSTA

Whisk - Fouet

Schneebesen - Batidor

Cod. 509164..



cm	Euro
----	------

45	15,90
----	-------

50	16,80
----	-------

55	18,20
----	-------

60	20,95
----	-------

Utensili da cucina

Kitchen utensils Ustensiles de cuisine Profiküchenhelfer Piezas de cocina

APPENDI ORDINI IN ALLUMINIO

Order rack

Cod. 78500325

cm	Euro
----	------

91	28,00
----	-------



SPATOLA DRITTA

Slimline spatula

Cod.	cm	Euro
78500410	16	6,50
78500412	20	7,00
78500413	23,5	7,55
78500414	29	8,00



SPATOLA DRITTA CON PIEGA

Turner round and flexible spatula

Cod.	cm	Euro
78500420	18	9,50
78500421	20	10,00
78500422	25	10,55



SPATOLA PER CUCINARE

Grill scraper spatula

Cod.	cm	Euro
78500430	7,5	7,55
78500431	10	8,80
78500432	12,5	9,35
78500433	15	10,00



PINZA CUOCO PUNTE PIEGATE

German tong bend - Pinza cocinero

Cod.	cm	Euro
78500440	35	9,65
78500441	45	12,00



BATTICARNE PROFESSIONALE MANICO ACCIAIO

Meat mallet with steel handle - Battoir à viande avec manche en acier
Fleischklopfer - Picador de carne con mango de acero



Cod.	gr	Euro
50907306	600	23,00
50907315	1500	48,00

ROMPINOCI 2 NICCHIE

Nutcracker - Casse-noix - Nussknacker - Cascanueces
Cod. 50916001



Master	Euro
40	11,00

CAVATAPPI 2 LEVE

Cork screw - Tirebouchon - Korkenzieher - Sacacorchos
Cod. 50916200



Master	Euro
72	7,00

TRINCIAPOLLO CON MOLLA INTERNA

Poultry shears (internal spring) - Coupe-volailles (ressort intérieur)
Geflügelschere (Interne Feder) - Tijeras para aves
Cod. 50907400



cm	master	Euro
25	30	22,50

RACCOGLI BRICIOLE

Crumb collector - Ramasse-miettes - Tischkrümelsammler - Recoge migas
Cod. 50916600



Master	Euro
240	1,95

Tongs Pinces Zangen Pinzas

MOLLA ARROSTO PROFESSIONALE

Roast meat tong - Pince à rôti

Bratenzange - Pinza para asado

Cod. 50919701

lungh. cm	master	Euro
26	36	17,50



MOLLA SPAGHETTI PROFESSIONALE

Spaghetti tong - Pince à spaghetti

Spaghetizange - Pinza para espaguetis

Cod. 50919601

lungh. cm	master	Euro
26	36	17,50



MOLLA GASTRONORM PROFESSIONALE

Gastronorm tong - Pince gastronorm

Gastronormzange - Pinza gastronorm

Cod. 50919901

lungh. cm	master	Euro
26	36	25,20



MOLLA PANE PROFESSIONALE

*Bread tong - Pince à pain
Brotzange - Pinza para pan*

Cod. 50919501



lungh. cm	master	Euro
26	36	25,20

MOLLA INSALATA PROFESSIONALE

*Salad tong - Pince à salade
Salatzange - Pinza para ensalada*

Cod. 50919001



lungh. cm	master	Euro
26	36	19,70

PINZA DEL CUOCO

*Chef tong - Pince de chef
Chefzange - Pinza del cocinero*

Cod. 50918131



lungh. cm	master	Euro
31,5	-	5,10

Molle Buffet

inox
18/10

Tongs Pinces Zangen Pinzas

MOLLA SERVIZIO BUFFET

Serving tongs

Pinza de servir

Cod. 58137224

lungh. cm	master	Euro
24	12	5,50



MOLLA ARROSTO BUFFET

Roast meat tongs

Pinza para asado

Cod. 58136024

lungh. cm	master	Euro
24	12	5,50



MOLLA UNIVERSALE BUFFET

Universal tongs

Pinza universal

Cod. 58137324

lungh. cm	master	Euro
24	12	5,50



MOLLA PANE BUFFET

Bread tongs

Pinza para pan

Cod. 58136824

lungh. cm	master	Euro
24	12	5,50



MOLLA VERDURE BUFFET

Vegetables tongs

Pinza para verduras

Cod. 58137424

lungh. cm	master	Euro
24	12	5,50





MOLLA INSALATA BUFFET

Salad tongs
Pinza para ensalada
Cod. 58136620

lungh. cm	master	Euro
20	12	5,25



MOLLA MULTIUSO BUFFET

Multi purpose tongs
Pinza multiusos
Cod. 58137524

lungh. cm	master	Euro
24	12	5,50



MOLLA DOLCE BUFFET

Cake tongs
Pinza para pastel
Cod. 58136124

lungh. cm	master	Euro
24	12	5,50



MOLLA SPAGHETTI BUFFET

Spaghetti tongs
Pinza para espaguetis
Cod. 58136924

lungh. cm	master	Euro
24	12	5,50

MOLLA DOLCE

Cake tongs - Pince à gâteau

Gebäckzange - Pinza para pastel

Cod. 50919400

lungh. cm	master	Euro
20	120	2,95



MOLLA PANE

Bread tongs - Pince à pain

Brotzange - Pinza para pan

Cod. 50919500

lungh. cm	master	Euro
22	120	3,10



MOLLA SPAGHETTI

Spaghetti tongs - Pince à spaghetti

Spaghetti-Zange - Pinza para espaguetis

Cod. 50919600

lungh. cm	master	Euro
20	120	2,95



MOLLA ARROSTO

Roast tongs - Pince à rôti

Bratenzange - Pinza para asado

Cod. 50919700

lungh. cm	master	Euro
21	120	2,95



MOLLA LUMACHE

Snails tongs - Pince à escargots
Schneckenzange - Pinza para caracoles

Cod. 50919800



lungh. cm	master	Euro
16	24	4,75

MOLLA ZUCCHERO INOX

Sugar tongs - Pince à sucre
Zuckerzange - Pinza para azucar

Cod. 50919100



lungh. cm	master	Euro
11	200	1,45

MOLLA GHIACCIO ELITE

Ice tongs Elite - Pince à glace Elite
Eiszange Elite - Pinza para hielo

Cod. 50918900



lungh. cm	master	Euro
15	24	4,70

MOLLA GHIACCIO DENTATA INOX 18/10

Ice tongs inox 18/10 - Pince à glace inox 18/10
Eiszange mit Zähnen inox 18/10 - Pinza para hielo inox 18/10

Cod. 50919300



lungh. cm	master	Euro
16	80	7,70

MOLLA GHIACCIO

Ice tongs - Pince à glace
Eiszange - Pinza para hielo

Cod. 50919200

lungh. cm	master	Euro
13	200	2,35



FORBICE DOLCE

Cake tongs - Pince à gâteau
Gebäckschere - Pinza para pastel

Cod. 50918000

lungh. cm	master	Euro
20	120	5,85



PINZA AFFETTATI

Sliced meat tongs - Pince à charcuterie
Aufschnittzange - Pinza para embutidos

Cod. 50907100

lungh. cm	master	Euro
10	100	7,35



**PASSA THE**

*Tea strainer - Passoire in the
Teesieb - Filtro para té*

Cod. 78000238



lungh. cm	master	Euro
-----------	--------	------

22	24	6,70
----	----	------

PALA TAGLIA FORMAGGI

Cheese slicer - Pelle coupe fromage

Käsehobel - Pala cortar quesos

Cod. 78000265



lungh. cm	master	Euro
-----------	--------	------

21	24	5,50
----	----	------

PALA TORTA SEGHETTATA

Cake server - Pelle à tarte dentelée

Tortenheber - Pala servir pastel

Cod. 78000259



lungh. cm	master	Euro
-----------	--------	------

26	24	6,50
----	----	------

PALA PIZZA SEGHETTATA

Pizza pie-cutter - Pelle à pizza dentelée

Pizzaheber - Pala cortar pizza

Cod. 78000232



lungh. cm	master	Euro
-----------	--------	------

27	24	7,00
----	----	------

PALA UOVO

Egg lifter - Pelle à oeufs

Durchbrochener Pfannenwender - Pala para huevos

Cod. 78000256

lungh. cm	master	Euro
25	24	5,80



FRUSTA PIATTA

Flat whisk - Fouet plat

Platter Schneebesener - Batidor llano

Cod. 790414..

lungh. cm	master	Euro
20	24	4,40
25	24	5,00



GRATTUGGIA PICCOLA DA TAVOLO

Fine handy grater - Râpe petite

Muskatreibe - Rallador de mesa

Cod. 78002806

lungh. cm	master	Euro
26	24	4,75



GRATTUGGIA PIATTA DA TAVOLO

Fine handy grater - Râpe platte

Zitronenreibe - Rallador llano de mesa

Cod. 78002807

lungh. cm	master	Euro
24	24	4,60



TAGLIA PASTA*Pastry cutter - Roulette coupe-pâte**Plate Teigrädchen - Rodillo cortar pasta***Cod. 78000242**

lungh. cm	master	Euro
-----------	--------	------

18,5	24	4,55
------	----	------

TAGLIA PIZZA*Pizza pie cutter - Roulette coupe-pizza**Pizza/Teigrädchen - Rodillo cortar pizza***Cod. 78000243**

lungh. cm	master	Euro
-----------	--------	------

18,5	24	4,25
------	----	------

TAGLIA PASTA/PIZZA 2 RUOTE*2 Wheels pastry/pizza cutter - Coupe-pizza à 2 roulettes**Doppelteigrädchen - Cortador de pasta/pizza 2 rodillos***Cod. 78000244**

lungh. cm	master	Euro
-----------	--------	------

14	24	5,10
----	----	------

SPATOLA LUNGA*Long spatula - Spatule longue**Schnale Wender - Espátula larga***Cod. 78000264**

lungh. cm	master	Euro
-----------	--------	------

34	24	6,50
----	----	------

SPATOLA LARGA

*Big spatula - Spatule large
Breiter Wender - Espátula ancha*

Cod. 78000270

lungh. cm	master	Euro
26,5	24	6,90



SCHIACCIA PATATE

*Potato masher - Presse-purée
Kartoffelstampfer - Prensa-puré*

Cod. 78000549

lungh. cm	master	Euro
30	24	9,75

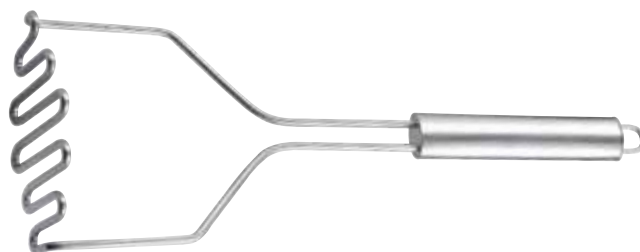

CUCCHIAIONE

*Serving spoon - Cuiller de service
Servierlöffel - Cuchara servir*

Cod. 7805217B

lungh. cm	master	Euro
32,5	24	8,40



CUCCHIAIONE FORATO

*Slotted spoon - Cuiller de service perforé
Gelochter Servierlöffel - Cuchara servir perforada*

Cod. 7805218B

lungh. cm	master	Euro
32,5	24	8,40



**FORCHETTONE**

Fork - Fourchette de service
Serviergabel - Tenedor servir

Cod. 7805215B

lungh. cm	master	Euro
-----------	--------	------

32	12	8,40
----	----	------

**MESTOLO cm 9**

Soup ladle - Louche
Suppenlöffel - Cazo sopa

Cod. 7805211B

lungh. cm	master	Euro
-----------	--------	------

30	12	10,00
----	----	-------

**MESTOLO cm 6**

Soup ladle - Louche
Saucenlöffel - Cazo sopa

Cod. 7805212B

lungh. cm	master	Euro
-----------	--------	------

28	12	9,50
----	----	------

**SCHIUMAROLA cm 11**

Skimmer - Ecumoire
Schaumlöffel - Espumadera

Cod. 7805213B

lungh. cm	master	Euro
-----------	--------	------

36,5	12	9,70
------	----	------

PALA FRITTO

Turner - Pelle avec trous
Bratenwender - Pala fritos

Cod. 7805214B

lung. cm	master	Euro
33	12	8,30



APPENDINO 5 POSTI

Hanger 5 hooks - Barrette 5 pièces
Hängeleiste 5 plätze - Asta colgador 5 ganchos

Cod. 71000013

lung. cm	master	Euro
33	24	4,75



QUINTIGLIA CON ASTA

5 Pc kitchentool set with hanger
Set 5 pièces avec barrette
Profiküchenhelfer 5tlg. mit Aufhängeleiste

Juego cocina 5 piezas con calgador

composto da 6 pz:

Mestolo 9 cm

Schiumarola 11 cm

Forchettone

Pala Fritto

Cucchiaione

Appendino 5 posti

Consisting of 6 pcs:

Ladle, Skimmer, Serving fork, Spatula,

Serving spoon, Hanger.

Composé de 6 pièces:

Louche, Ecumoire, Fourchette à servir, Pelle,

Cuiller à servir, Barrette.

Besteht aus 6 Teilen:

Suppenshöpfer, Fleischgabel, Bratenwender,

Bratenspatula, Aufhängeleiste.

Compuesto de 6 piezas:

Cazo, Espumadera, Tenedor, Pala fritos,

Cucharón, Colgador.

Cod. 7805219B

master	Euro
-	49,50



**CUCCHIAIO ARRICCIABURRO***Butter curler - Cuiller coquilleur à beurre**Butterformer - Rizador de mantequilla***Cod. 78000233**

lungh. cm	master	Euro
-----------	--------	------

18	24	4,35
----	----	------

**FORCHETTA CARNE 2 PUNTE***Utility fork - Fourchette à viande 2 dents**Fleischgabel - Tenedor carne***Cod. 78000230**

lungh. cm	master	Euro
-----------	--------	------

18,5	24	3,50
------	----	------

**ARRICCIABURRO***Butter curler - Coquilleur à beurre**Butterroller - Rizador de mantequilla***Cod. 78000269**

lungh. cm	master	Euro
-----------	--------	------

19	24	3,90
----	----	------

**SCAVINO 22 mm***Melon baller - Creuse pommes de terre**Kugelausstecher - Vaciador***Cod. 78000228**

lungh. cm	master	Euro
-----------	--------	------

18	24	4,00
----	----	------

DOSATORE GELATO

Ice-cream scoop - Portionneur à glace

Eisportionierer - Dosificador helado

Cod. 78000268

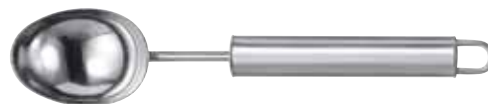

lungh. cm	master	Euro
-----------	--------	------

23,5	24	5,70
------	----	------

SCAVINO 28 mm

Melon baller - Creuse pommes de terre

Kugelausstecher - Vaciador

Cod. 78000229



lungh. cm	master	Euro
-----------	--------	------

18,5	24	5,95
------	----	------

FORCHETTA PATATE

Potato fork - Fourchette à pommes de terre

Kartoffelgabel - Tenedor de patatas

Cod. 78000234



lungh. cm	master	Euro
-----------	--------	------

16	24	4,10
----	----	------

PELAPATATE

Peeler - Eplucheur à pommes de terre

Sparschäler - Pelapatatas

Cod. 78000271



lungh. cm	master	Euro
-----------	--------	------

18,5	24	4,00
------	----	------

RIGA LIMONI

*Lemon zester - Zesteur
Fadenschneider - Pelador*

Cod. 78002805



lungh. cm	master	Euro
-----------	--------	------

15,5	24	4,00
------	----	------

PELATATE MULTIUSO

*Peeler - Eplucheur
Sparschäler - Pelador multiuso*

Cod. 78000225



lungh. cm	master	Euro
-----------	--------	------

18,5	24	4,50
------	----	------

APRIBOTTIGLIA E FORA LATTINE

*Bottle opener - Décapsuleur
Kapselheber - Abrebotellas*

Cod. 78000255



lungh. cm	master	Euro
-----------	--------	------

18,5	24	9,30
------	----	------

SEPARATORE UOVA

*Egg divider - Séparateur jaune d'oeuf
Eiertrenner - Separador de claras*

Cod. 78000266

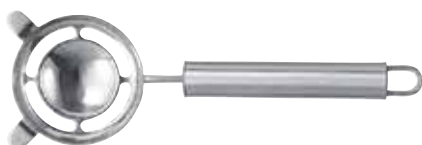

lungh. cm	master	Euro
-----------	--------	------

20,5	24	4,50
------	----	------

APRIBARATTOLI UNIVERSALE

Jar opener - Ouvre bocaux

Deckelöffner - Abridor de tarros

Cod. 78000901



lungh. cm	master	Euro
-----------	--------	------

23,5	10	15,60
------	----	-------

APRISCATOLE

Can opener - Ouvre-boîtes

Dosenöffner - Abrelatas

Cod. 78000682



lungh. cm	master	Euro
-----------	--------	------

20	10	13,10
----	----	-------

SPREMIAGLIO

Garlic press - Presse-ail

Knoblauchpresse - Ex-primeajos

Cod. 78000868



lungh. cm	master	Euro
-----------	--------	------

28,5	10	13,70
------	----	-------

CANNULA LEVA TORSOLO

Apple corer - Vide-pommes

Apfelausstecher - Decorazonador

Cod. 78000227



lungh. cm	master	Euro
-----------	--------	------

18,5	24	3,70
------	----	------

GRATTACAROTE*Vegetable scraper - Eplucheur carottes**Karottenschaber - Pelador de zanahorias* **Cod. 78000267**

lungh. cm	master	Euro
-----------	--------	------

23,5	24	3,60
------	----	-------------

MANARETTA*Meat cleaver - Couperet**Käsehackbeil - Macheta* **Cod. 78000251**

lungh. cm	master	Euro
-----------	--------	------

23,5	24	7,10
------	----	-------------

MANARETTA PICCOLA*Meat cleaver - Couperet petit**Käsehackbeil - Macheta pequeña***Cod. 78000250**

lungh. cm	master	Euro
-----------	--------	------

20,5	24	5,40
------	----	-------------

COLTELLO FORMAGGIO 2 PUNTE*Cheese knife - Couteau à fromage**Käsemesser - Cuchillo queso***Cod. 78002803**

lungh. cm	master	Euro
-----------	--------	------

24,5	24	4,25
------	----	-------------

COLTELLO DA CUCINA LUNGO SEGHETTATO (LAMA cm 17)

Kitchen knife - Couteau à viande

Brotmesser - Cuchillo carne

Cod. 78002801

lungh. cm	master	Euro
29	24	5,20



COLTELLO MEDIO SEGHETTATO

Kitchen knife - Couteau de cuisine moyen

Tomatenmesser - Cuchillo de cocina medio

Cod. 78002804

lungh. cm	master	Euro
24	24	3,90



COLTELLO BISTECCA

Steak knife - Couteau à bifteck

Küchenmesser cm10 - Cuchillo chuletero cm 10

Cod. 78002802

lungh. cm	master	Euro
22	24	4,15



COLTELLO SPELUCCHINO

Paring knife - Couteau office

Küchenmesser cm7,5 - Cuchillo chuletero cm 7,5

Cod. 78002800

lungh. cm	master	Euro
19,5	24	4,75



Barbeque

Barbeque Barbeque Barbecue Barbacoa

MOLLA BARBEQUE

*Barbeque tongs - Pince à barbeque
Barbecue-zange - Pinza para barbacoa*

Cod. 50918301



lungh. cm	master	Euro
42,5	6	19,85

PALA BARBEQUE

*Barbeque turner - Pelle à barbeque
Barbecue-wender - Pala para barbacoa*

Cod. 50918302



lungh. cm	master	Euro
44,5	6	15,45

FORCHETTONE BARBEQUE

*Barbeque fork - Fourchette à barbeque
Barbecue-gabel - Tenedor para barbacoa*

Cod. 50918303



lungh. cm	master	Euro
44,5	6	10,45

SPAZZOLA BARBEQUE

Barbeque brush - Pinceau barbeque
Barbecue-Bürste - Brocha - barbacoa

Cod. 50918304

lungh. cm	master	Euro
44,5	6	17,80



SET 4 PZ BARBEQUE

4 pc barbeque set - Barbeque set 4 pièces
4 tlg barbecue-set - Set 4 piezas barbacoa

Cod. 50918300

Euro 58,00



Bar

Utensils

Articles de bar

Barartikel

Menaje de cafetería



Per alimenti
Suitable for foodstuffs
Apte au contact avec les aliments
Für Lebensmittel
Apto para alimentos



Garantito per lavastoviglie
Dishwasher safe
Inalterable dans lave-vaisselle
Spelmaschinenfest
Apto para lavavajillas

Utensils Articles de bar Barartikel Menaje de cafeteria

TAPPO CHAMPAGNE INOX 18/10

Champagne stopper inox 18/10 - Bouchon inox 18/10

Champagneverschluss inox 18/10 - Tapón champan inox 18/10

Cod. 50953305

master	Euro
-	15,50



TAPPO VINO PVC

Pvc wine stopper - Bouchon vin PVC

Weinverschluss - Tapón vino pvc

Cod. colour Euro

50953306	yellow	6,50
50953307	bordeaux	



CAVATAPPI PROFESSIONALE

Professional corkscrew - Tire-bouchon

Profikorkenzieher - Sacacorchos

Cod. 50953B00

master	Euro
60	3,70



CHIUDIBOTTIGLIA INOX

Stainless steel bottle stopper - Bouchon en inox

Edelstahlflaschenverschluss - Tapon de inox

Cod. 50953A00

master	Euro
60	7,25



ZUCCHERIERA OVALE COMPLETA DI 2 CUCCHIAINI MOD. PITAGORA

Oval sugar bowl with 2 tea/spoons - Sucrier oval avec 2 cuillères à café
Ovale Zuckerdose mit 2 Loeffeln - Azucarero ovalada con 2 cucharitas

Cod. 50958600



cm	Euro
21x13	79,50

ZUCCHERIERA TONDA COMPLETA DI 2 CUCCHIAINI MOD. PITAGORA

Round sugar bowl with 2 tea/spoons - Sucrier rond avec 2 cuillères à café
Runde Zuckerdose mit 2 Loeffeln - Azucarero redonda con 2 cucharitas

Cod. 50958500



Ø cm	Euro
14	62,50

SPILLONE PORTA SCONTRINI

Bill spike - Epingle porte-tickets
Couponnadel - Aguja porta tickets

Cod. 50916500



master	Euro
48	4,50

COLINO COCKTAIL ELLISSE INOX 18/10

Cocktail strainer

Cod. 50951700

cm	master	Euro
22,5	24	9,95



COLINO BAR 2 REBBI PESANTE INOX 18/10

Bar strainer heavy

Cod. 78500381

Euro 6,60



SPREMI LIME INOX 18/10

Lime squeezer

Cod. 78500305

Euro 2,50



PORTA TOVAGLIOLI

Napkin holder

Cod. 55014300

cm	Euro
11,5X8,5	5,80





SESSOLA

Ice/sugar big spoon - Librador

Cod. 78500301

Cod.	Lt	Euro
78500315	0,06	7,55
78500317	0,250	11,00
78500318	0,500	18,20
78500319	0,700	19,00



PORTA BUSTINE

Sugar display - Porta sobres azucar

Cod. 55014400

cm	Euro
10,5x5,5	5,25



COCKTAIL SHAKER DE LUXE INOX 18/10

Cocktail shaker de luxe - Coctelera luxe

Cod. 78500300

Lt	Euro
0,35	12,75



SHAKER BOSTON INOX 18/10

Boston shaker - Shaker inox 18/10

Cod. 78500307

Lt	Euro
0,50	13,50

COCKTAIL SHAKER 2 PZ

Cocktail shaker 2 pcs

Cod. 78500301

Lt	Euro
----	------

0,63	23,00
------	-------



COLINO BAR 2 REBBI LARGO

Bar strainer large

Cod. 78500380

Euro 8,20



COLINO BAR SEMPLICE

Bar strainer 2 mm

Cod. 78500385

Euro 10,55



DOSATORE DOPPIO ELLISSE

(1 oz - 2 oz)

Double jigger - Doseur double

Doppeldosiereinrichtung - Dosificador doble

Cod. 50951600



cm	master	Euro
23	12	10,50

COLINO COCKTAIL ELLISSE

Cocktail strainer - Passoire à cocktail

Cocktailsieb - Filtro para cocktail

Cod. 50951700



cm	master	Euro
22,5	24	9,95

MIXER ELLISSE

Mixer - Mélangeur

Mixer - Mezllador

Cod. 50951800



cm	master	Euro
25	24	4,35

Gelateria

DOSATORE MANICO VUOTO

H-H ice cream soop



Cod.	misura	Euro
78500396	medum	18,00
78500397	big	19,00

SPATOLA PER GELATO INOX

Ice cream spatula - Spatule à glace

Eisspachtel - Paleta para helado

Cod. 50952800

cm	master	Euro
18,5	100	4,60



SPATOLA PER GELATO MANICO IN PLASTICA

Ice cream spatula with plastic handle

Spatule à glace avec manche en plastique

Eisservier mit Kunststoffgriff

Paleta para helado con mango de plástico

Cod.	colour	cm	master	Euro
50952601	red	26	600	6,90
50952602	blue			
50952603	yellow			
50952604	green			
50952605	white			
50952606	rose			
50952607	black			



SPATOLA PER GELATO IN POLICARBONATO

PC ice cream spatula - Spatole à glace en PC

PC Eisservier - Paleta para helado de PC

Cod.	colour	cm	master	Euro
50952707	black	27	100	4,50
50952708	transparent			



SPATOLA PER GELATO CON MANICO IN PLASTICA

Ice cream spatula with plastic handle
Spatule à glace avec manche en plastique
Eisserver mit Kunststoffgriff
Paleta para helado con mango de plástico



Cod.	colour	cm	master	Euro
50952701	white	30	100	7,90
50952702	green			
50952703	red			

DOSATORE GELATO

Ice cream scoop - Doseur pour glace
Eisportionierer - Dosificador helado



Cod.	cm	master	Euro
79004018	4,1	12	14,50
79004020	5,0	12	16,50
79004022	6,3	12	17,50



PALETTA GELATO

Ice cream spoon - Cuillère à glace
Eislöffel - Cuchara para helado

Cod.	descriz.	cm	master	Euro
19900022	50/P inox	13,2	120	1,00
17100022	BETA inox 18/10	13,6	120	1,56
21500022	GAMMA inox 18/10	13,6	120	1,56
22400022	AMERICA inox 18/10	13,1	120	1,52
22600022	SIRIO inox 18/10	13,7	120	1,65
08100022	PITAGORA inox 18/10	13,6	120	1,94
16900022	PALACE inox 18/10	14,4	120	1,85
08000022	BYRON inox 18/10	13,6	120	1,94

PIATTINO CASSATA LISCIO

Ice cream plate - Plat à cassate

Cassata platte - Platile

Cod. 50952013

Ø cm	master	Euro
13	-	8,70



PIATTINO PER COPPA BORDATO

Edged plate - Plat bordé

Eisschale Untersatz - Platile

Cod. 50952113

Ø cm	master	Euro
13	-	6,50



COPPA GELATO CONICA

Conical ice cream goblet - Coupe à glace conique

Konische Eisschale - Copa para helado conica

Cod. 50950685

Ø cm	master	Euro
8,5	6	13,50



COPPA GELATO GAMBO BASSO

Ice cream goblet - Coupe à glace

Eisschale niedrig - Copa para helado

Cod. 50950210

Ø cm	master	Euro
10	6	7,50



COPPA GELATO GAMBO ALTO CILINDRICO

Ice cream goblet - Coupe à glace

Eisschale hoch - Copa para helado

Cod. 509504..

Ø cm	master	Euro
9	6	12,00
10	6	12,50





Grupo BRAMONIX

CONDICIONES GENERALES DE VENTA MERCADO NACIONAL

Al efectuar el pedido, el cliente acepta íntegramente las condiciones de venta y envío del siguiente encarte:

- **PRECIOS.** Los precios de la actual tarifa se entienden por mercancía puesta en nuestros almacenes de Valls (Tarragona).

La mercancía se factura al precio en vigor en el momento de envío del pedido.

La empresa se reserva la facultad de modificar en cualquier momento el precio de venta.

- **ENVÍOS.** Los pedidos cuyo valor sobrepase los 300€ se remitirán franco portes y embalajes en península y Baleares*.

- **RECLAMACIONES.** La mercancía viaja por cuenta y riesgo del cliente, aunque la misma viaje franco de portes. El cliente debe verificar la mercancía en el momento de su recepción. Toda reclamación referente a la cantidad o calidad de la mercancía, deberá ser notificada en plazo máximo de ocho días de la recepción de la misma.

- **FORMA DE PAGO.** La indicada en el pedido.

- **GARANTÍA.** El plazo de la presente garantía es de dos años a partir de la fecha de compra del producto, y cubre los posibles defectos de fabricación, y no cubre los defectos derivados de un mal uso de la pieza, uso impropio de esta o los daños causados por golpes.

Para hacer efectiva la presente garantía, el consumidor deberá dirigirse siempre al establecimiento en que haya comprado el producto, acompañado del justificante de compra. Sólo en el caso de que lo anterior resulte imposible o excesivamente costoso, el consumidor podrá dirigirse al fabricante a fin de reclamar la reparación o sustitución del producto, remitiéndolo por correo ordinario a: GRUPO BRA MONIX, c/ Basters 4, Polígono Industrial, (43800) Valls, Tarragona (ESPAÑA).

Los posibles productos defectuosos cubiertos por esta garantía serán recepcionados, reparados y/o reemplazados sin gastos, y devueltos al comprador sin cargo alguno.

Esta garantía no afecta a los derechos de que dispone el consumidor conforme a lo previsto en el RDL 1/2007,

Ley General para la Defensa de los Consumidores y Usuarios. La presente se interpretará conforme a las leyes de España, siendo competentes para dirimir cualquier posible diferencia los tribunales de España.

* En el caso de que el producto haya sido adquirido en un país distinto a España, para hacer efectiva la presente garantía, el consumidor deberá dirigirse siempre al establecimiento en que haya comprado el producto, acompañado del justificante de compra. Sólo en el caso de que lo anterior resulte imposible o excesivamente costoso, el consumidor podrá dirigirse al importador que el referido establecimiento le indique.

LA ACTUAL LISTA DE PRECIOS ANULA Y SUSTITUYE CUALQUIER OTRA ANTERIOR QUE OBRE EN SU PODER.

* Canarias: portes pagados hasta el puerto de partida desde la península hacia Canarias.

GRUPO BRA MONIX
C. Basters, 4 - 43800 VALLS (SPAIN)

Tel. +34 977 607 025
comercial@bramonix.com



bra@braisogona.com



comercial@monix-original.com



Grupo

BRAMONIX

Basters, 4
43800 **VALLS** (SPAIN)
comercial@bramonix.com
www.braisogona.com - www.monix.es

